

Service  
Service  
**Service**



# Service Manual

## TABLE OF CONTENTS

	Page
Location of PCB Boards & version variation & repair scenario matrix.....	1-2
Production Specifications .....	1-3
Safety Instruction, Warning & Notes.....	1-7
DFU Instruction.....	2-1
Mechanical and Dismantling Instructions .....	3-1
Software Upgrades.....	4-1
Trouble Shooting Chart .....	5-1
Wiring Diagrams .....	6-1
Electrical Diagrams and Print-layouts .....	7-1
Set Mechanical Exploded view .....	8-1
Revision List .....	9-1



© Copyright 2010 Philips Consumer Electronics B.V. Eindhoven, The Netherlands  
All rights reserved. No part of this publication may be reproduced, stored in a retrieval system or transmitted, in any form or by any means, electronic, mechanical, photocopying, or otherwise without the prior permission of Philips.

Published by Helen-RY 1216 Service Audio Printed in The Netherlands Subject to modification

© 313978536220

Version 1.0



# PHILIPS

**PCB BOARD LOCATION:**

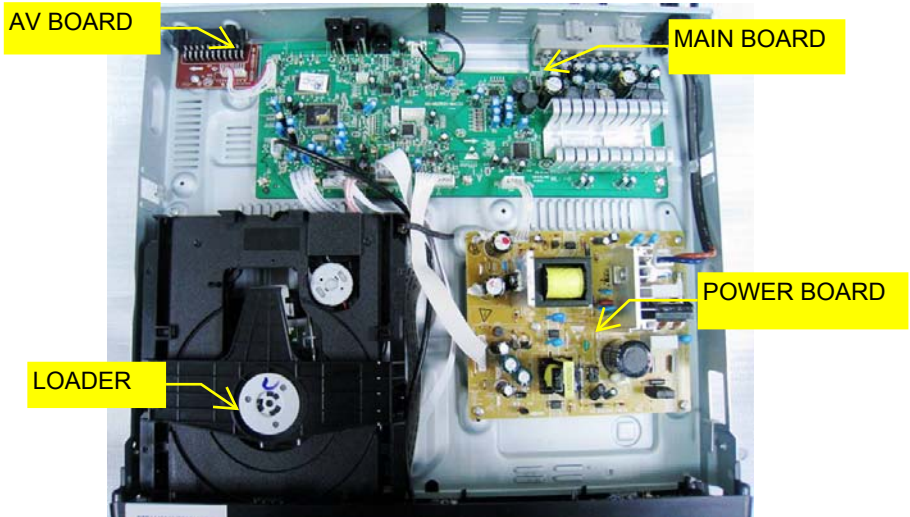

**Version Variation**

Type/Versions  Features	HTS2512
	/94
Power supply rating:220-240V ,50Hz	X
Power consumption:55W	X

**Repair Scenario Matrix**

Type/Versions  Board in used	HTS2512
	/94
Main Board	C
Front Control Board	C
Amplifier Board	C
Power Board	C

\*Bd:Board Level Replacement

\*C:Component Level Repair

HTS2512/94

## Product Specifications

### Note

- Specifications and design are subject to change without notice.

### Region codes

The type plate on the back or bottom of the home theater shows which regions it supports.

Country	DVD
Europe, United Kingdom	 
Russia, India	 

### Media formats

- DVD-Video, DVD+R/+RW, DVD-R/-RW, DVD+R/-R DL, CD-R/CD-RW, Audio CD, Video CD/SVCD, Picture files, MP3 media, WMA media, DivX media, USB storage device

### File formats

- Audio: .mp3, .wma
- Video: .avi, .divx, .mpg, .mpeg,
- Picture: .jpg, .jpeg

### Amplifier

- Total output power: 300W RMS (30% THD)
- Frequency response: 20 Hz-20 kHz /  $\pm 3$  dB
- Signal-to-noise ratio:  $> 65$  dB (CCIR) / (A-weighted)
- Input sensitivity:
  - AUX: 2 V

### Video

- Signal system: PAL / NTSC
- Component video output: 480i/576i, 480p/576p, 720p, 1080i

### Audio

- S/PDIF Digital audio input:
  - Coaxial: IEC 60958-3
  - Optical: TOSLINK
- Sampling frequency:
  - MP3: 32 kHz, 44.1 kHz, 48 kHz
  - WMA: 44.1 kHz, 48 kHz
- Constant bit rate:
  - MP3: 32 kbps - 320 kbps
  - WMA: 128 bps - 192 kbps

### Radio

- Tuning range:
  - Europe/Russia/China: FM 87.5-108 MHz (50 kHz)
  - Asia Pacific/Latin America: FM 87.5-108 MHz (50/100 kHz)
- Signal-to-noise ratio: FM  $> 45$  dB
- Frequency response: FM 200 Hz-12.5 kHz /  $\pm 6$  dB

### USB

- Compatibility: Hi-Speed USB (2.0)
- Class support: USB Mass Storage Class (MSC)
- File system: FAT16, FAT32

### Main unit

- Power supply:
  - Europe/China/Russia/India: 220-240V~, 50 Hz
  - Latin America/Asia Pacific: 110-240V~, 50-60 Hz
- Power consumption: 55 W
- Standby power consumption:  $\leq 0.9$  W
- Dimensions (WxHxD): 360 x 58 x 325 mm
- Weight: 2.35 kg

---

### Subwoofer

- Output power: 50 W RMS (30%THD)
- Impedance: 8 ohm
- Speaker drivers: 133 mm (5.25") woofer
- Dimensions (WxHxD): 195 x 265 x 265 mm
- Weight: 2.61 kg

---

### Speakers

#### Center speaker:

- Output power: 50 W RMS (30%THD)
- Speaker impedance: 4 ohm
- Speaker drivers: 1 x 70 mm (2.75") woofer
- Dimensions (WxHxD): 84.5 x 89 x 89 mm
- Weight: 0.27 kg

#### Front/Rear speaker:

- Output power: 4 x 50 W RMS (30%THD)
- Speaker impedance: 4 ohm
- Speaker drivers: 1 x 70 mm (2.75") woofer
- Dimensions (WxHxD): 84.5 x 89 x 89mm
- Weight: 0.25-0.29 kg/each

---

### Remote control batteries

- 2 x AAA-R03-1.5 V

---

### Laser

- Type: Semiconductor laser GaAlAs (CD)
- Wave length: 645 - 665 nm (DVD), 770 - 800 nm (CD)
- Output power: 6 mW (DVD), 7 mW (VCD/CD)
- Beam divergence: 60 degrees.

## Safety instruction, Warning & Notes

### Safety instruction

---

#### 1. General safety

Safety regulations require that during a repair:

- . Connect the unit to the mains via an isolation transformer.
- . Replace safety components indicated by the symbol ▲, only by components identical to the original ones. Any other component substitution (other than original type) may increase risk of fire or electrical shock hazard.

Safety regulations require that after a repair, you must return the unit in its original condition. Pay, in particular, attention to the following points:

- . Route the wires/cables correctly, and fix them with the mounted cable clamps.
- . Check the insulation of the mains lead for external damage.
- . Check the electrical DC resistance between the mains plug and the secondary side:
  - 1) Unplug the mains cord, and connect a wire between the two pins of the mains plug.
  - 2) Set the mains switch the "on" position (keep the mains cord unplug).
  - 3) Measure the resistance value between the mains plug and the front panel, controls, and chassis bottom.
  - 4) Repair or correct unit when the resistance measurement is less than 1M $\Omega$ .
  - 5) Verify this, before you return the unit to the customer/user (ref. UL-standard no. 1492).
  - 6) Switch the unit "off", and remove the wire between the two pins of the mains plug.

#### 2.Laser safety

This unit employs a laser. Only qualified service personnel may remove the cover, or attempt to service this device (due to possible eye injury).

Laser device unit

Type	: Semiconductor laser GaAlAs
Wavelength	: 650nm (DVD)
	: 780nm (VCD/CD)
Output power	: 7mW (DVD)
	: 10mW (DVD /CD)

Beam divergence: 60 degree

Note: Use of controls or adjustments or performance of procedure other than those specified herein, may result in hazardous radiation exposure. Avoid direct exposure to beam.

## Warning

---

### 1. General

. All ICs and many other semiconductors are susceptible to electrostatic discharges (ESD). Careless handling during repair can reduce life drastically. Make sure that, during repair, you are at the same potential as the mass of the set by a wristband with resistance. Keep components and tools at this same potential. Available ESD protection equipment:

- 1) Complete kit ESD3 (small tablemat, wristband, connection box, extension cable and earth cable) 4822 310 10671.
- 2) Wristband tester 4822 344 13999.

. Be careful during measurements in the live voltage section. The primary side of the power supply, including the heat sink, carries live mains voltage when you connect the player to the mains (even when the player is "off!"). It is possible to touch copper tracks and/or components in this unshielded primary area, when you service the player. Service personnel must take precautions to prevent touching this area or components in this area. A "lighting stroke" and a stripe-marked printing on the printed wiring board, indicate the primary side of the power supply.

. Never replace modules, or components, while the unit is "on".

### 2. Laser

- . The use of optical instruments with this product, will increase eye hazard.
- . Only qualified service personnel may remove the cover or attempt to service this device, due to possible eye injury.
- . Repair handling should take place as much as possible with a disc loaded inside the player.
- . Text below is placed inside the unit, on the laser cover shield:

**CAUTION: VISIBLE AND INVISIBLE LASER RADIATION WHEN OPEN, AVOID EXPOSURE TO BEAM.**

Notes: Manufactured under licence from Dolby Laboratories. The double-D symbol is trademarks of Dolby Laboratories, Inc. All rights reserved.

## Service Hints

### CAUTION

**CHARGED CAPACITORS ON THE SERVO BOARD MAY DAMAGE THE DRIVE ELECTRONICS WHEN CONNECTING A NEW DRIVE. THAT'S WHY, BESIDES THE SAFETY MEASURES LIKE**

- SWITCH OFF POWER SUPPLY
- ESD PROTECTION

**ADDITIONAL ACTIONS MUST BE TAKEN BY THE REPAIR TECHNICIAN.**

### The following steps have to be done when replacing the defective loader :

1. Dismantling of the loader to access the ESD protection point if necessary.
2. **Solder the ESD protection point\***.
3. Disconnect flexfoil cable from the defective loader.
4. Put a paper clip on the flexfoil to short-circuit the contacts (fig.1)
5. Replace the defective loader with a new loader.
6. Remove paperclip from the flexfoil and connect it to the new loader.
7. Remove solder joint on the ESD protection point.

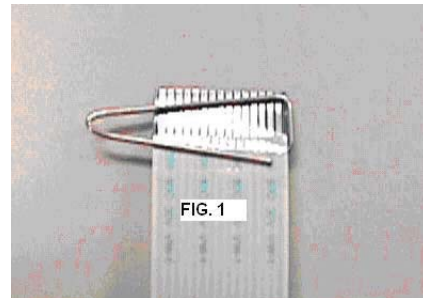

ATTENTION: The laser diode of this loader is protected against ESD by a solder joint which shortcircuits the laserdiode to ground. For proper functionality of the loader this solder joint must be remove **after** connection loader to the set.

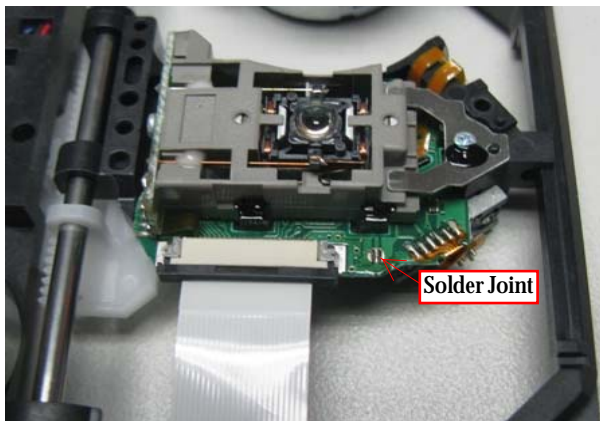

(ESD protection point is accessible from top of loader)

***\*Only applicable for defective loader needed to be sent back to supplier for failure analysis and to support backcharging evidence.***

***This is also applicable for all partnership workshops.***

## Notes

### Lead-Free requirement for service

---

#### IDENTIFICATION:

Regardless of special logo (not always indicated) 

One must treat all sets from 1.1.2005 onwards, according next rules.

*Important note: In fact also products a little older can also be treated in this way as long as you avoid mixing solder-alloys (leaded/ lead-free). So best to always use SAC305 and the higher temperatures belong to this.*

Due to lead-free technology some rules have to be respected by the workshop during a repair:

- Use only lead-free solder alloy Philips SAC305 with order code 0622 149 00106. If lead-free solder-paste is required, please contact the manufacturer of your solder-equipment. In general use of solder-paste within workshops should be avoided because paste is not easy to store and to handle.
  - Use only adequate solder tools applicable for lead-free solder alloy. The solder tool must be able
    - To reach at least a solder-temperature of 400°C,
    - To stabilize the adjusted temperature at the solder-tip
    - To exchange solder-tips for different applications.
  - Adjust your solder tool so that a temperature around 360°C – 380°C is reached and stabilized at the solder joint. Heating-time of the solder-joint should not exceed ~ 4 sec. Avoid temperatures above 400°C otherwise wear-out of tips will rise drastically and flux-fluid will be destroyed. To avoid wear-out of tips switch off un-used equipment, or reduce heat.
  - Mix of lead-free solder alloy / parts with leaded solder alloy / parts is possible but PHILIPS recommends strongly to avoid mixed solder alloy types (leaded and lead-free). If one cannot avoid, clean carefully the solder-joint from old solder alloy and re-solder with new solder alloy (SAC305).
- Use only original spare-parts listed in the Service-Manuals. Not listed standard-material (commodities) has to be purchased at external companies.
  - Special information for BGA-ICs:
    - always use the 12nc-recognizable soldering temperature profile of the specific BGA (for de-soldering always use highest lead-free temperature profile, in case of doubt)
    - lead free BGA-ICs will be delivered in so-called 'dry-packaging' (sealed pack including a silica gel pack) to protect the IC against moisture. After opening, dependent of MSL-level seen on indicator-label in the bag, the BGA-IC possibly still has to be baked dry. This will be communicated via AYS-website.
  - Do not re-use BGAs at all.
  - For sets produced before 1.1.2005, containing leaded soldering-tin and components, all needed spare-parts will be available till the end of the service-period. For repair of such sets nothing changes.
  - On our website:
    - [www.atyourservice.ce.Philips.com](http://www.atyourservice.ce.Philips.com)**

You find more information to:

BGA-de-/soldering (+ baking instructions)  
Heating-profiles of BGAs and other ICs used in Philips-sets

You will find this and more technical information within the "magazine", chapter "workshop news".  
For additional questions please contact your local repair-helpdesk.





- EN** Before using your product, read all accompanying safety information
- CS** Před použitím produktu si přečtěte doprovodné bezpečnostní informace
- DA** Læs alle medfølgende sikkerhedsoplysninger, inden du tager produktet i brug
- DE** Lesen Sie vor Verwendung dieses Produkts alle begleitenden Sicherheitsinformationen
- EL** Πριν χρησιμοποιήσετε το προϊόν, διαβάστε όλες τις παρεχόμενες πληροφορίες ασφάλειας
- ES** Antes de usar el producto, lea toda la información de seguridad adjunta
- FI** Lue kaikki turvallisuuksiedot ennen tuotteen käyttöä
- FR** Avant d'utiliser votre produit, lisez l'intégralité des consignes de sécurité jointes
- HU** A termék használata előtt alaposan olvassa el a mellékelt biztonsági tudnivalókat
- IT** Prima di utilizzare il prodotto, leggere tutte le relative informazioni sulla sicurezza

- NL** Lees voordat u het product gaat gebruiken eerst alle bijbehorende veiligheidsinformatie
- NO** Lees voordat u het product gaat gebruiken eerst alle bijbehorende veiligheidsinformatie
- PL** Przed rozpoczęciem korzystania z produktu należy zapoznać się z informacjami dotyczącymi bezpieczeństwa
- PT** Antes de utilizar o produto, leia todas as informações de segurança que o acompanham
- RO** Înainte de a utiliza acest produs, citiți toate informațiile de siguranță care îl însoțesc
- SK** Pred použitím produktu si prečítajte všetky sprievodné bezpečnostné informácie maklumat keselamatan yang disertakan
- SV** Innan du använder produkten ska du läsa all tillhörande säkerhetsinformation
- TR** Ürününüzü kullanmadan önce ilgili tüm güvenlik bilgilerini okuyun

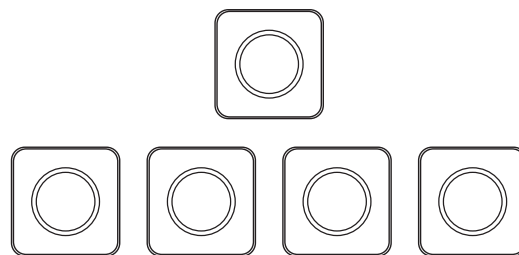
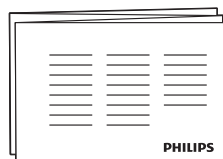
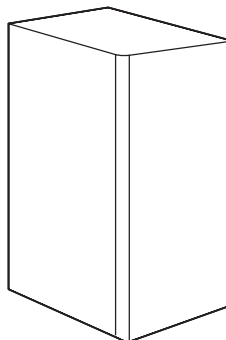
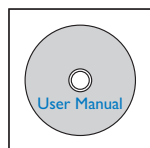
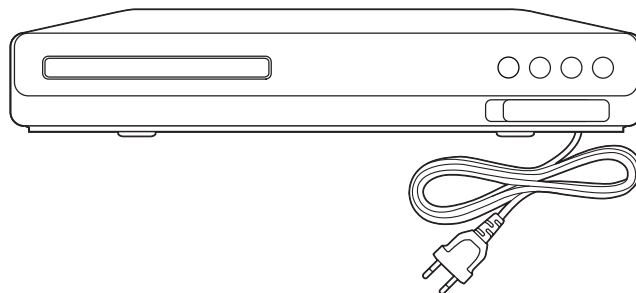
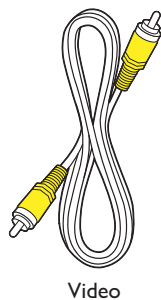
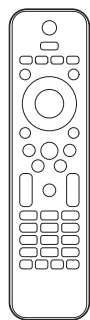

# 1

**EN** Connect the home theater

**CS** Připojte domácí kino

**DA** Tilslut hjemmebiografen

**DE** Anschließen des Home Entertainment-Systems

**EL** Συνδέστε το home cinema

**ES** Conecta el sistema de cine en casa

**FI** Kotiteatterin liitännät

**FR** Connecter les enceintes au Home Cinéma

**HU** A házimozi csatlakoztatása

**IT** Collegamento del sistema Home Theater

**NL** Sluit de home cinema aan

**NO** Koble til hjemmekinoanlegget

**PL** Podłączenie zestawu kina domowego

**PT** Efectuar as ligações ao sistema de cinema em casa

**RO** Conectați sistemul home theater

**SK** Pripojenie k domácemu kinu

**SV** Anslut hemmabiosystemet

**TR** Ev sinemasını bağlayın

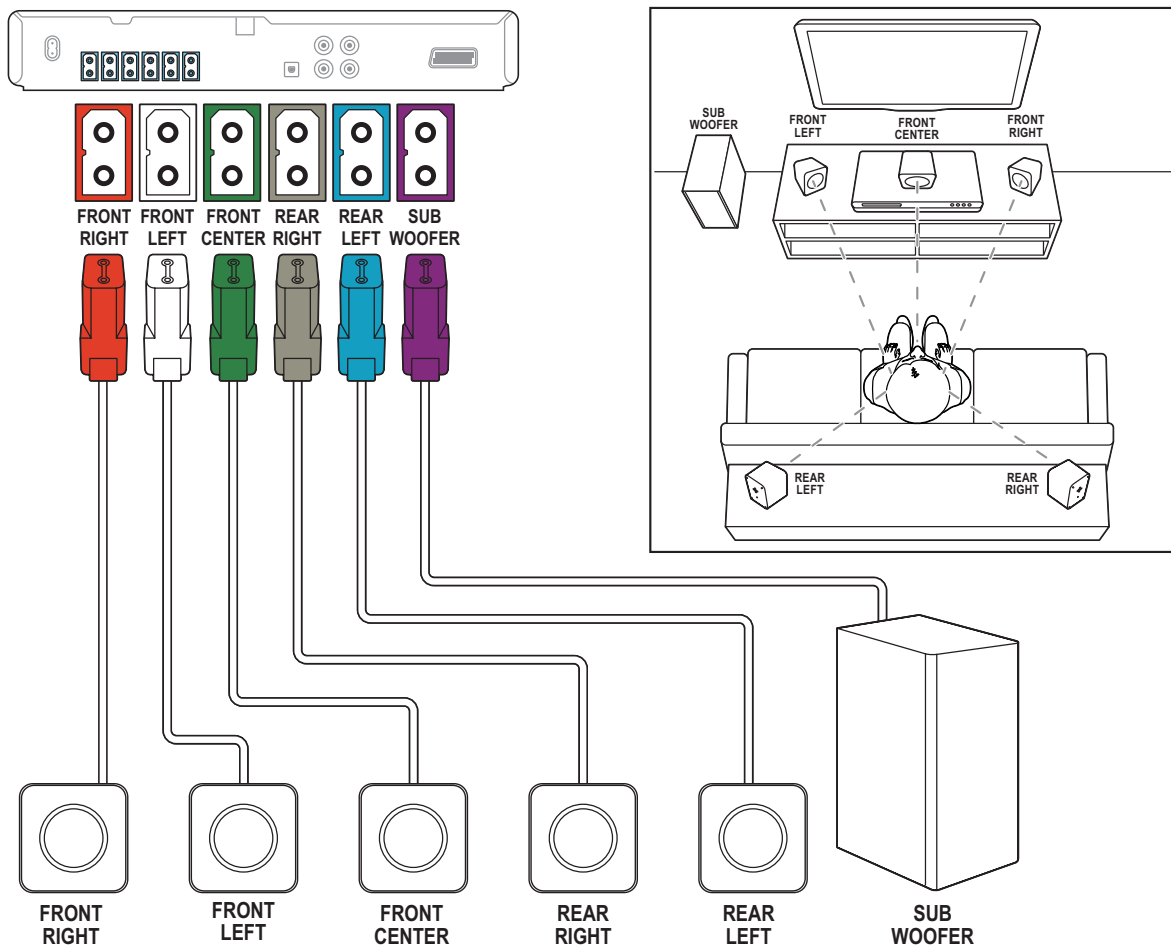

# 2

**EN** Connect to TV in one of these ways

**CS** Připojení k televizoru provedte jedním z následujících způsobů

**DA** Tilslut til TV på en af følgende måder

**DE** Herstellen einer Verbindung mit dem Fernseher über einer dieser Möglichkeiten

**EL** Συνδεθείτε στην τηλεόραση με έναν από τους παρακάτω τρόπους

**ES** Conexión al televisor de una de estas maneras

**FI** Liitä televisioon jommallakummalla tavalla

**FR** Connectez-vous au téléviseur via l'une de ces méthodes

**HU** Csatlakoztassa a tv-készülékhez az alábbi módok egyike szerint

**IT** Eseguì il collegamento al TV in uno dei modi indicati di seguito

**NL** Maak op een van de volgende manieren verbinding met de TV

**NO** Koble til TV'en på en av følgende måter

**PL** Podłącz do telewizora przy użyciu jednej z tych metod

**PT** Ligar ao televisor de uma destas formas

**RO** Conectați-vă la televizor într-unul din aceste moduri

**SK** Pripojte zariadenie k televizoru jedným z týchto spôsobov

**SV** Anslut till TV:n på något av följande sätt

**TR** Aşağıdaki yöntemlerden biriyle TV'ye bağlanın

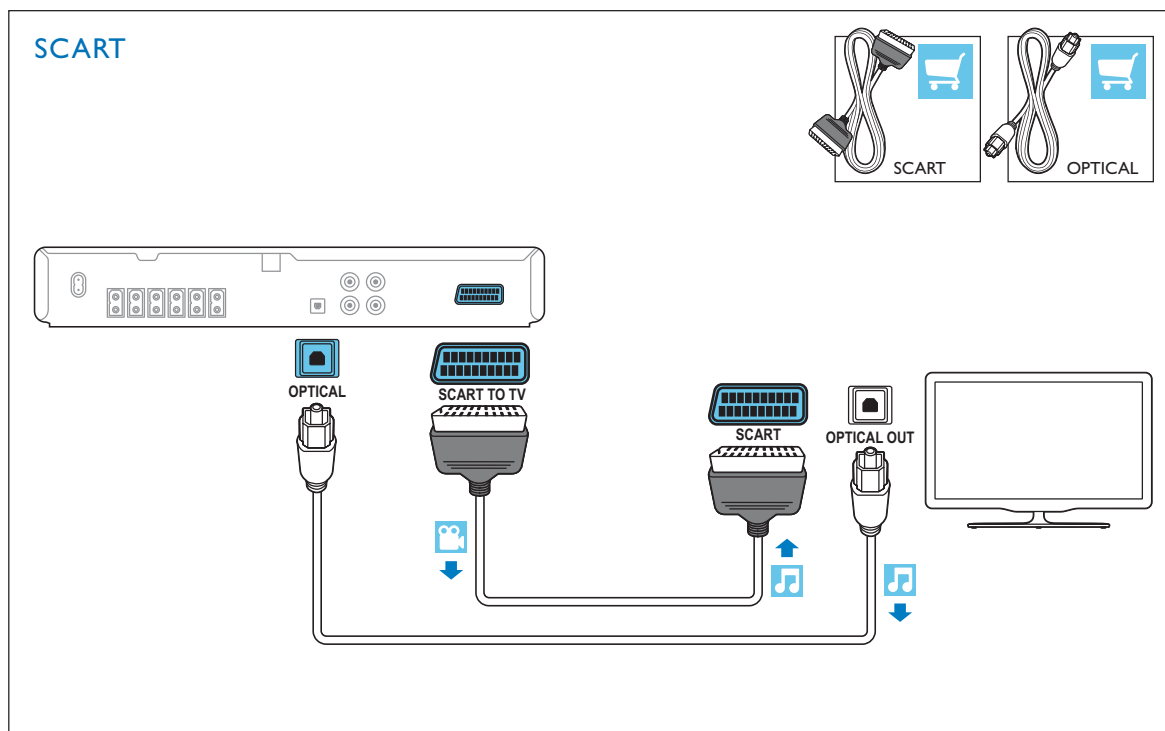

### VIDEO + AUDIO L/R

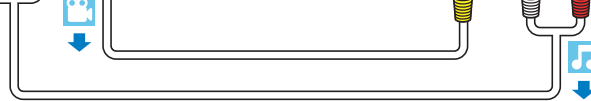
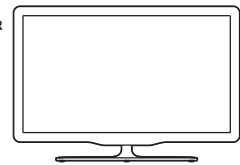
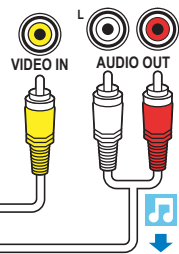
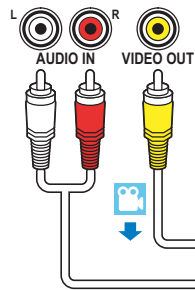
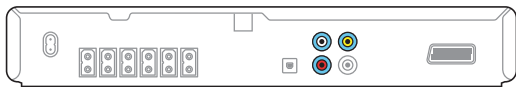

## 3

**EN** Switch on the home theater

**CS** Zapněte domácí kino

**DA** Tænd for hjemmebiografen

**DE** Einschalten des Home Entertainment-Systems

**EL** Ενεργοποιήστε το home cinema

**ES** Enciende el sistema de cine en casa

**FI** Virran kytkeminen kotiteatteriin

**FR** Mettre sous tension le Home Cinéma

**HU** A házimozi bekapcsolása

**IT** Accensione del sistema Home Theater

**NL** Schakel de home cinema in

**NO** Slå på hjemmekinoanlegget

**PL** Włączanie zestawu kina domowego

**PT** Ligar o sistema de cinema em casa

**RO** Porniți sistemul home theater

**SK** Zapnutie domáceho kina

**SV** Sätt på hemmabiosystemet

**TR** Ev sinemasını açın

1

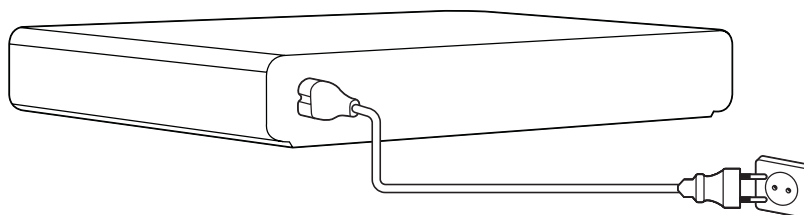

2

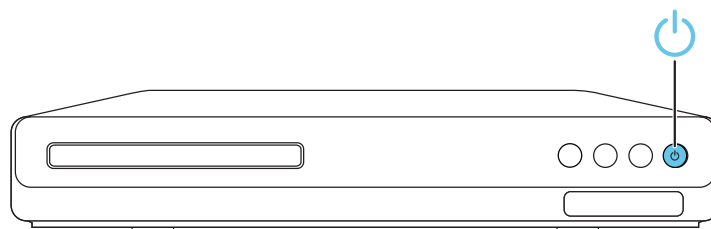

3

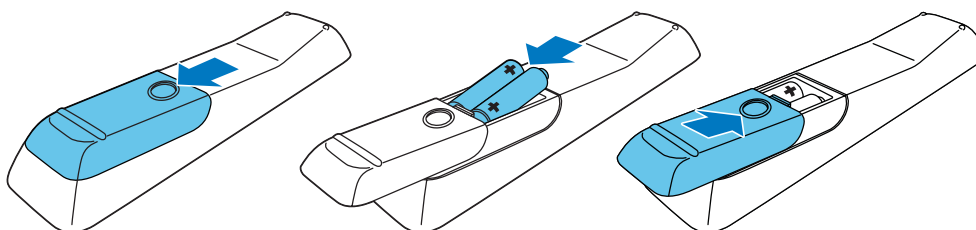

## 4

**EN** Complete the first time setup

**CS** Dokončili jste nastavení při prvním zapnutí

**DA** Fuldfør den indledende opsætning

**DE** Abschließen der Ersteinrichtung

**EL** Ολοκληρώστε τη ρύθμιση για πρώτη φορά

**ES** Finaliza la configuración inicial

**FI** Ensiasennuksen suorittaminen loppuun

**FR** Effectuer la configuration initiale

**HU** Az első üzembe helyezés

**IT** Completamento della configurazione iniziale

**NL** Voltooi de eerste installatie

**NO** Fullfør den første konfigureringen

**PL** Pierwsza konfiguracja

**PT** Executar a configuração inicial

**RO** Realizați prima configurare

**SK** Dokončenie prvého nastavenia

**SV** Slutför förstagångsinställningen

**TR** İlk kullanım öncesi kurulumunu tamamlayın

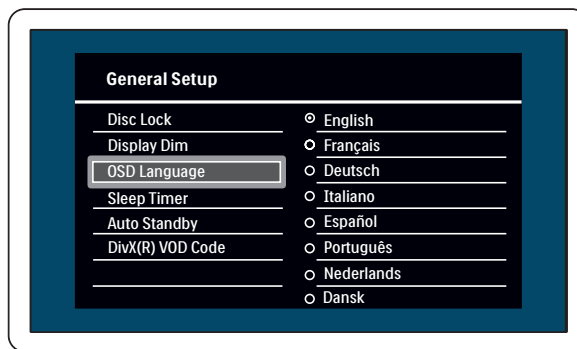
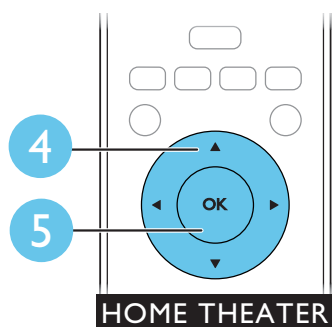
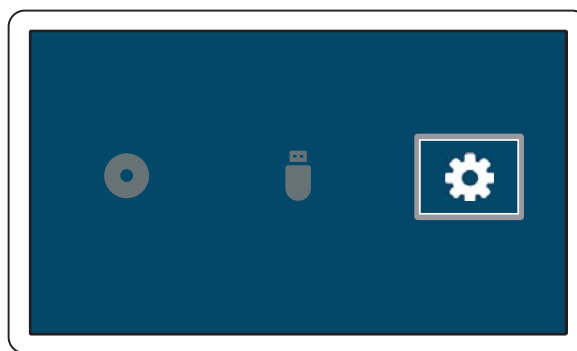
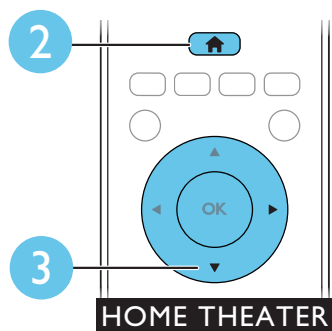
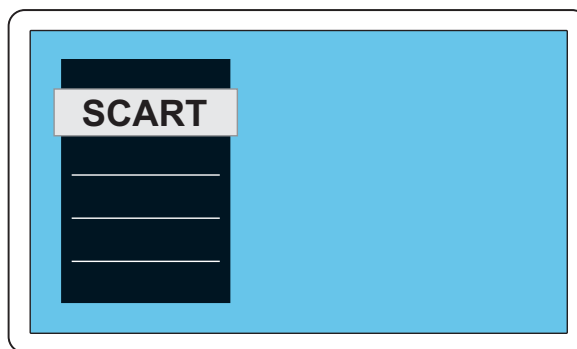
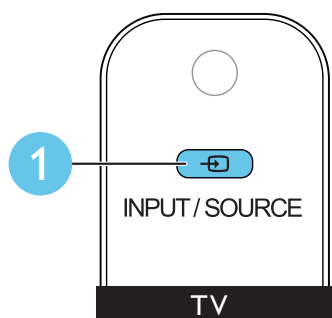

## 5

**EN** Use your home theater

**CS** Použití domácího kina

**DA** Brug af din hjemmebiograf

**DE** Verwenden des Home Entertainment-Systems

**EL** Χρησιμοποιήστε το home cinema

**ES** Uso del sistema de cine en casa

**FI** Kotiteatterin käyttäminen

**FR** Utiliser votre Home Cinéma

**HU** A házimozi használat

**IT** Utilizzo del sistema Home Theater

**NL** Uw home cinema bedienen

**NO** Bruke hjemmekinoanlegget

**PL** Korzystanie z zestawu kina domowego

**PT** Utilizar o sistema de cinema em casa

**RO** Utilizați sistemul home theater

**SK** Používanie domáceho kina

**SV** Använda hemmabiosystemet

**TR** Ev sinema sisteminin kullanılması

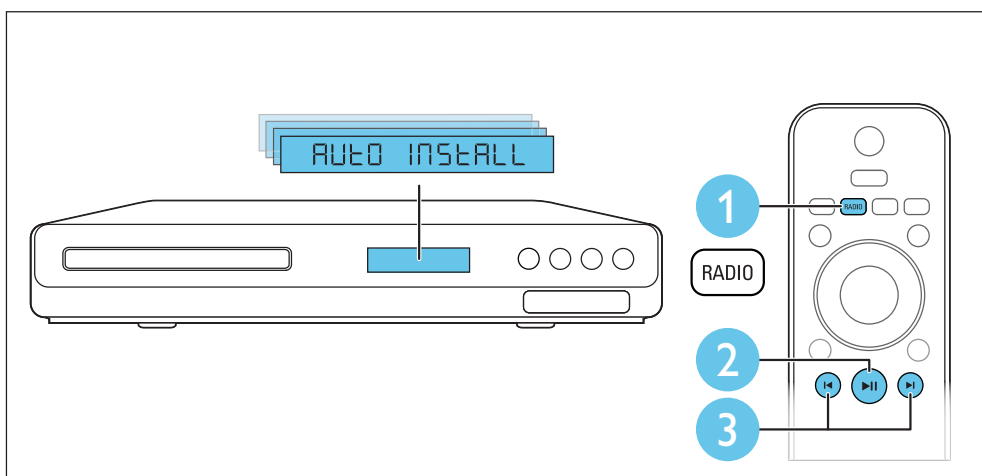
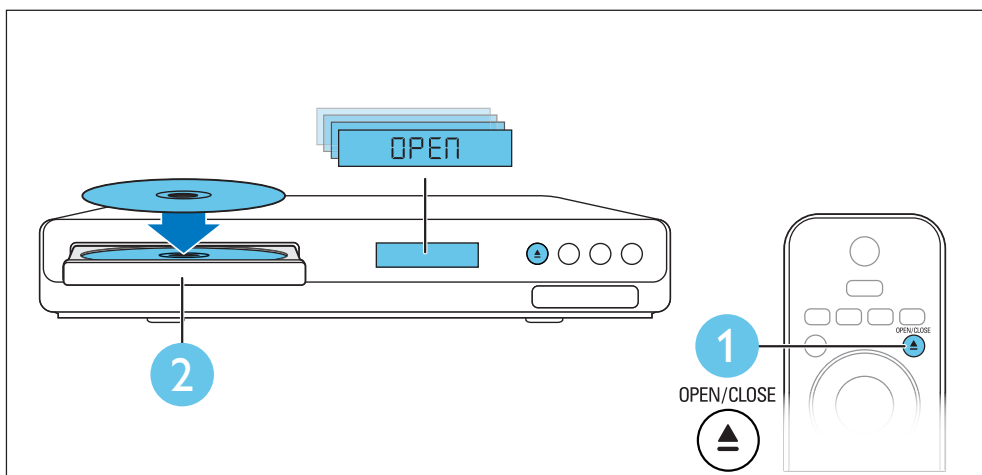

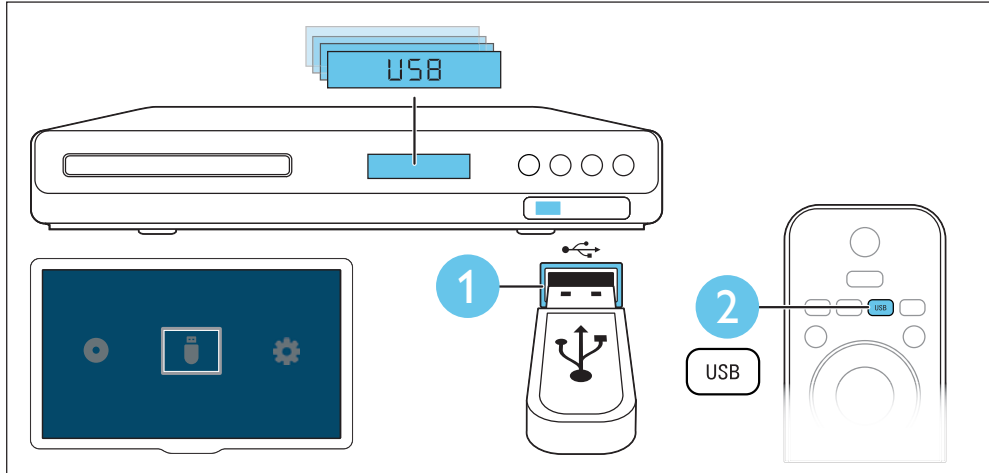



## Your home theater

Congratulations on your purchase, and welcome to Philips! To fully benefit from the support that Philips offers, register your product at [www.philips.com/welcome](http://www.philips.com/welcome).

### Main unit

This section includes an overview of the main unit.

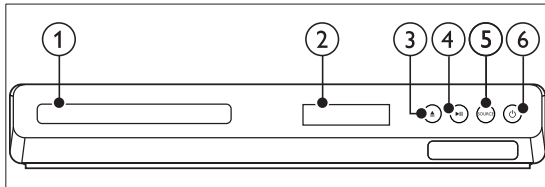

- ① Disc compartment
- ② Display panel
- ③ ▲ (Open/Close)  
Open or close the disc compartment, or eject the disc.
- ④ ▶|| (Play/Pause)  
Start, pause or resume play.
- ⑤ SOURCE  
Select an audio or video source for the home theater.
- ⑥ ⏻ (Standby-On)  
Switch the home theater on or to standby.









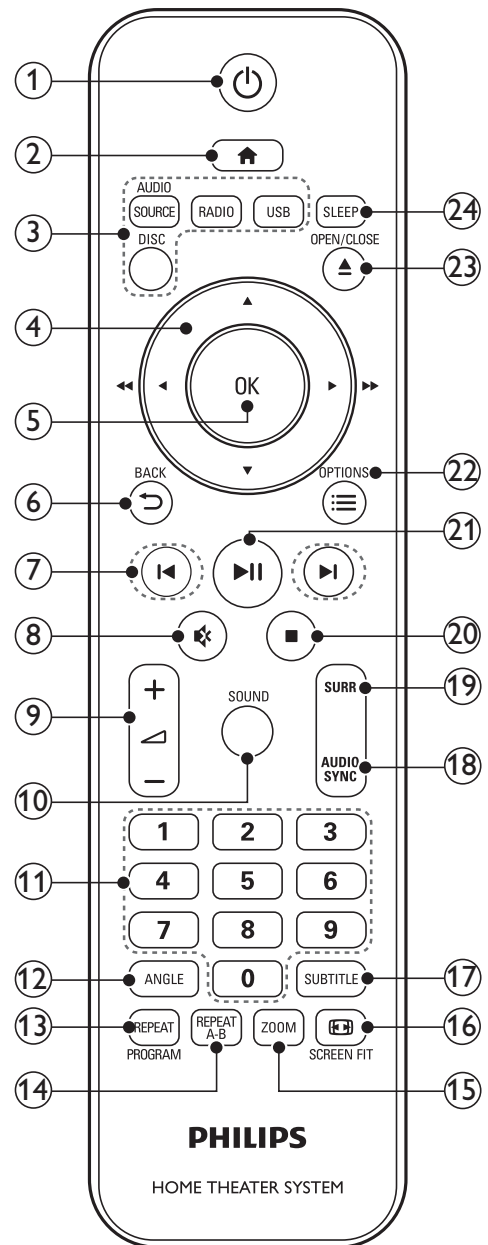

### Connectors

This section includes an overview of the connectors available on your home theater.

### Remote control

This section includes an overview of the remote control.



- ①  **(Standby-On)**  
Switch the home theater on or to standby.
- ②  **(Home)**  
Access the home menu.
- ③ **Source buttons**
- **DISC:** Switch to disc source. Access or exit the disc menu when you play a disc.
  - **AUDIO SOURCE:** Select an audio input source.
  - **RADIO:** Switch to FM radio.
  - **USB:** Switch to USB storage device.
- ④ **Navigation buttons**
- Navigate menus.
  - In video mode, press left or right to fast backward or fast forward; press up or down to slow backward or slow forward.
  - In radio mode, press left or right to search a radio station; press up or down to fine tune a radio frequency.
- ⑤ **OK**  
Confirm an entry or selection.
- ⑥  **BACK**  
Return to a previous menu screen.
- ⑦  **(Previous/Next)**
- Skip to the previous or next track, chapter or file.
  - In radio mode, select a preset radio station.
- ⑧  **(Mute)**  
Mute or restore volume.
- ⑨  **+/-**  
Increase or decrease volume.
- ⑩ **SOUND**  
Select a sound mode.
- ⑪ **Numeric buttons**  
Select an item to play.
- ⑫ **ANGLE**  
Select video scenes recorded in different camera angles.
- ⑬ **REPEAT / PROGRAM**
- Select or turn off repeat mode.
  - In radio mode, press once to access program mode, and press again to store the radio station.
  - In radio mode, press and hold for three seconds to reinstall the radio stations.
- ⑭ **REPEAT A-B**  
Mark two points within a chapter or track to repeat play, or turn off the repeat mode.
- ⑮ **ZOOM**  
Zoom into a video scene or picture. Press the **Navigation buttons** (left/right) to select a zoom factor.
- ⑯  **SCREEN FIT**  
Fit the picture format to the TV screen.
- ⑰ **SUBTITLE**  
Select subtitle language for video.
- ⑱ **AUDIO SYNC**
- Select an audio language or channel.
  - Press and hold to access audio delay setting, and then press the **Navigation buttons** to delay the audio to match the video.
- ⑲ **SURR**  
Select surround sound or stereo sound.
- ⑳  **(Stop)**
- Stop play.
  - In radio mode, press and hold to erase the current preset radio stations.
- ㉑  **(Play/Pause)**  
Start, pause or resume play.
- ㉒  **OPTIONS**  
Access more play options while playing a disc or a USB storage device.
- ㉓  **OPEN/CLOSE**  
Open or close the disc compartment, or eject the disc.
- ㉔ **SLEEP**  
Switch the home theater to standby mode after the elapsed time.

## Mechanical and Dismantling Instructions

### Dismantling Instruction

Detailed information please refer to the model set.

The following guidelines show how to dismantle the player.

**Step1:** Remove 6 screws around the Top Cover, and then remove the Top Cover (Figure 1).

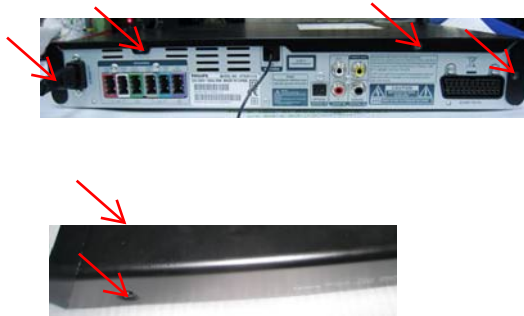

Figure 1

**Step2:** If it is necessary to dismantle Loader or Front Panel, the Front door should be removed first. (Figure 2)  
Turn on the power button, then press open button to dismantle front door. Please kindly note that power off as soon as front door is out of machine.

Note: Make sure to operate gently otherwise the guider would be damaged.



Please kindly note that dismantle the front door assembly carefully to avoid damage tray and the front door.

Figure 2

## Mechanical and Dismantling Instructions

### Dismantling Instruction

Detailed information please refer to the model set.

**Step3** :Dismantle Front Panel, disconnect the connectors (XP22, XP33), need release 2 snaps of Front Panel & 2 snaps of bottom cabinet , then gently pull the Panel out from the set. (Figure 3)

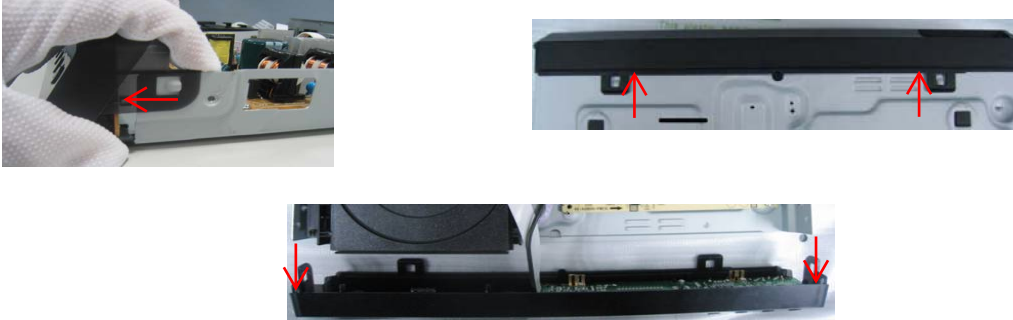

Figure 3

**Step4** : Dismantle Front Control Board,remove 5 screws (Figure 4 )

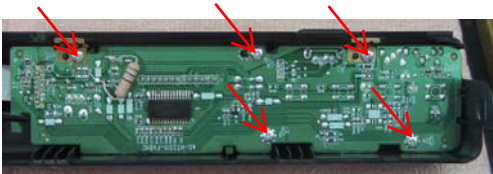

Figure 4

**Step5**: Dismantle Loader, disconnect the 3 connectors (XP9, XP2, XP8) aiming in the below figure, and remove 2 screws that connects the loader and the bottom cabinet. (Figure 5)

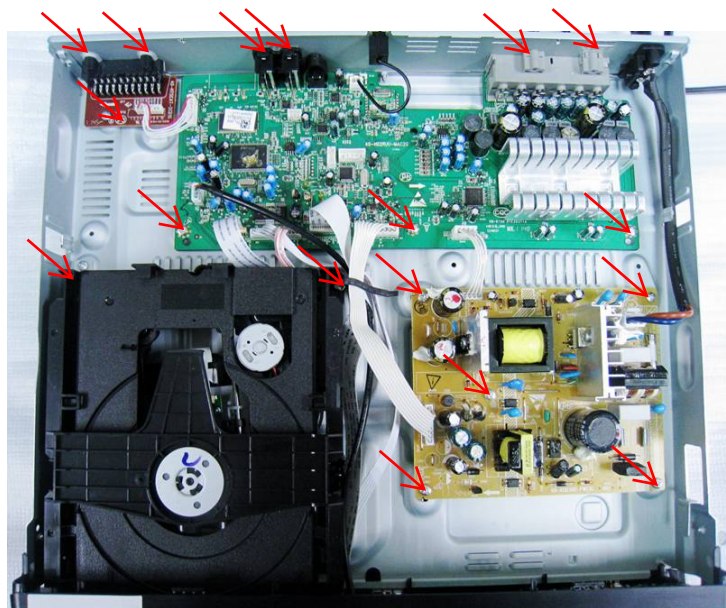

Figure 5

## Mechanical and Dismantling Instructions

### Dismantling Instruction

Detailed information please refer to the model set.

Step6: Dismantle Main Board, first disconnect 1 connector (XP36), and then remove 7 screws. (Figure 5/6)

Step7: Dismantle Power Board, disconnect the connectors XP3 and XS703 ,then remove 5 screws.(Figure 5/6)

Step8: Dismantle AV Board, first disconnect 1 connector(XP11),and then remove 3 screws (Figure 5/6)

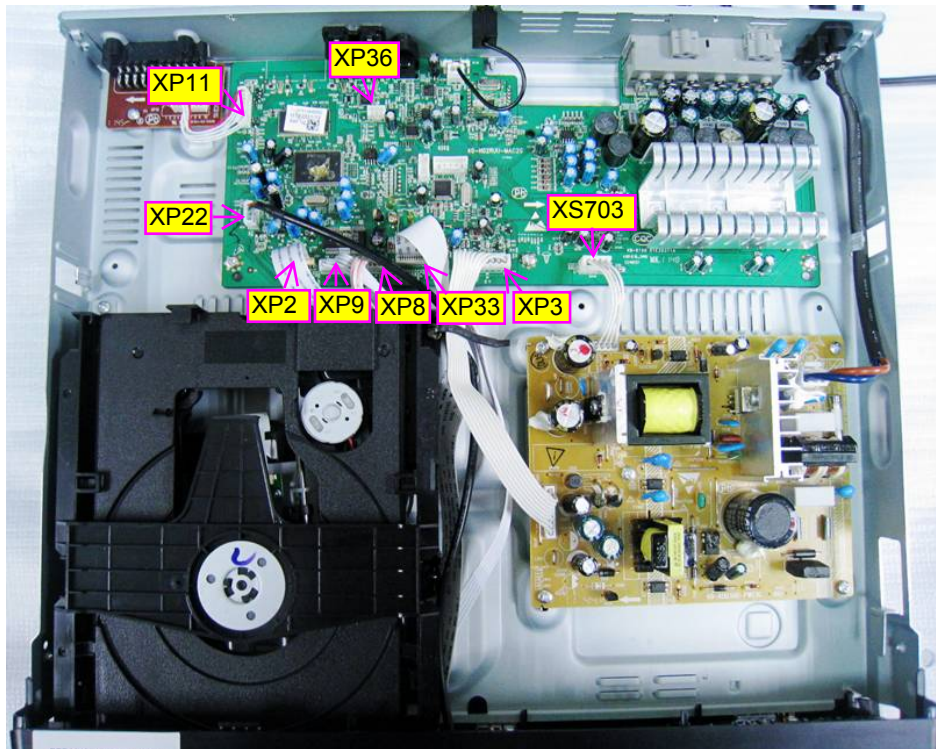

Figure 6

## Software upgrade

### Software upgrade method:

1. Copy the bin file as "HTS2512\_XX.bin".
2. Then use the file to burn the upgrade CD-R/CD-RW.
3. Put the CD in the tray ,let the player loading the disc.
4. If the CD is correct ,it will display the Upgrade Menu ,press the PLAY key on the remote control to start upgrade
5. Afer a while, the tray will open automatically ,but must not power off the player.
6. Don't power off ,wait until the player reset automatically ,the whole upgrade process may need 2 minutes .HTS will auto standby after complete upgrade.

### if you upgrade with USB device:

1. step1 is same with DISC upgrade;
2. Copy the renamed bin file(upgrade file) to the root menu of USB device.
3. connect the USB device to HTS ,and switch to USB source;
4. The rest is same to step 4,step 5 and step 6 with DISC upgrade.

Caution: The set must not be power off during upgrading, Otherwise the Main board will be damaged entirely.

### How to adjust the setting after repairing:

1. HTS2512/94: Open DVD tray, press "9" "9" "9" "9" "5" on R/C;

**Note: Restart after above steps.**

## LED No display on Front Control Board

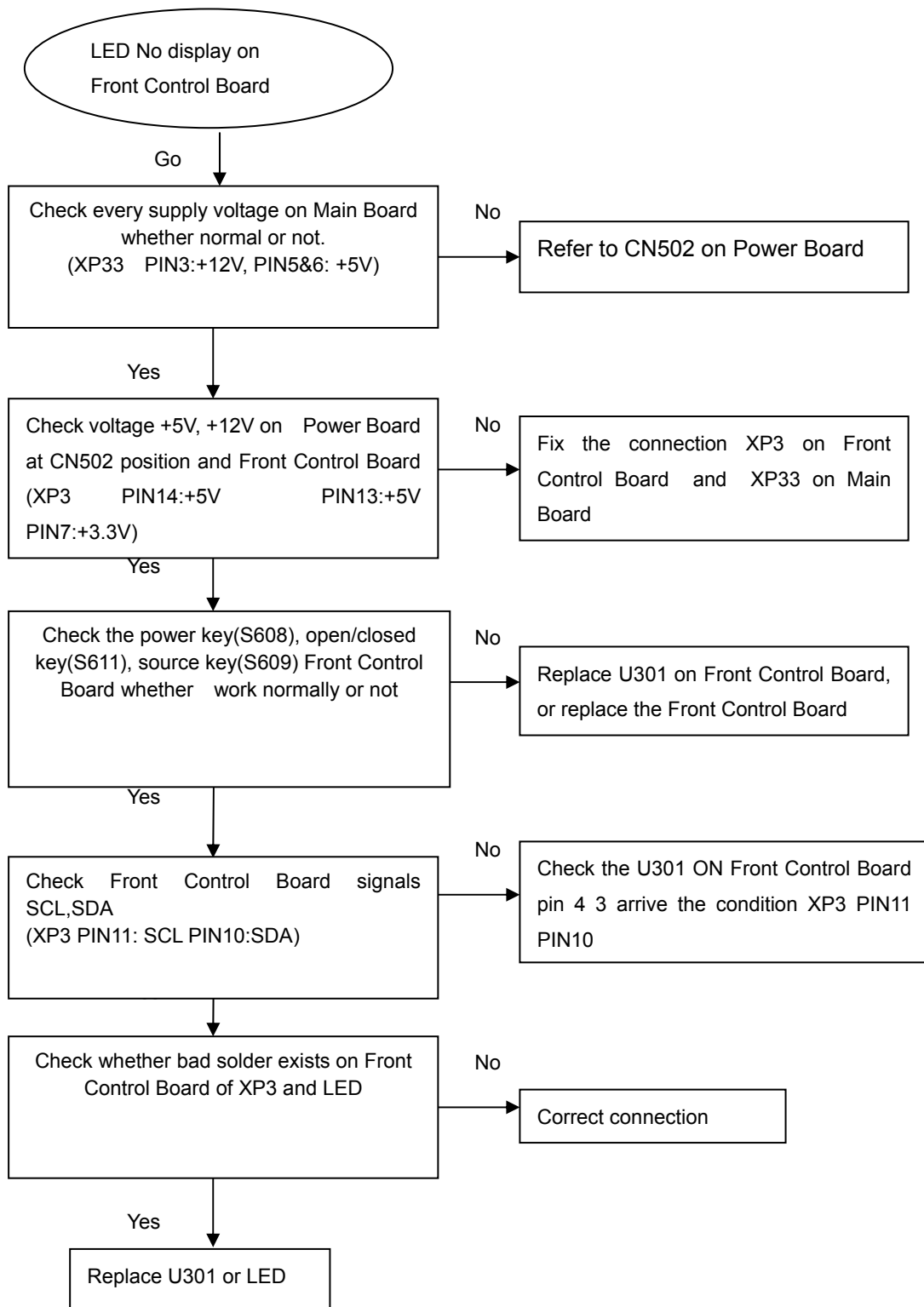

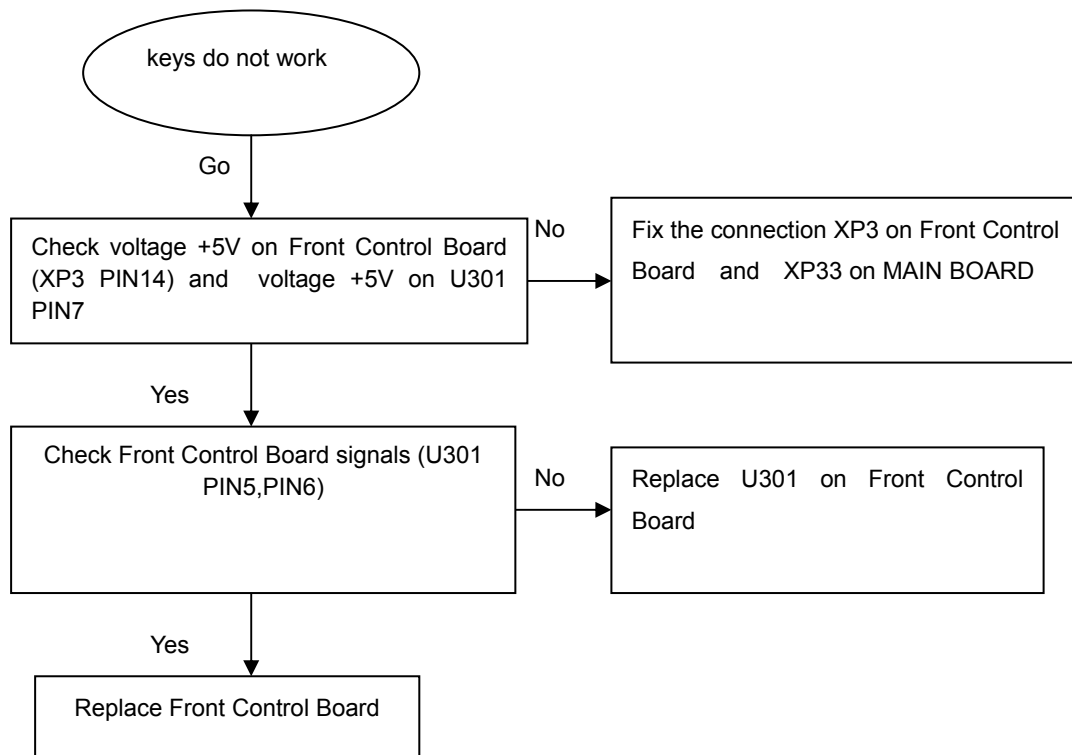
**keys do not work**

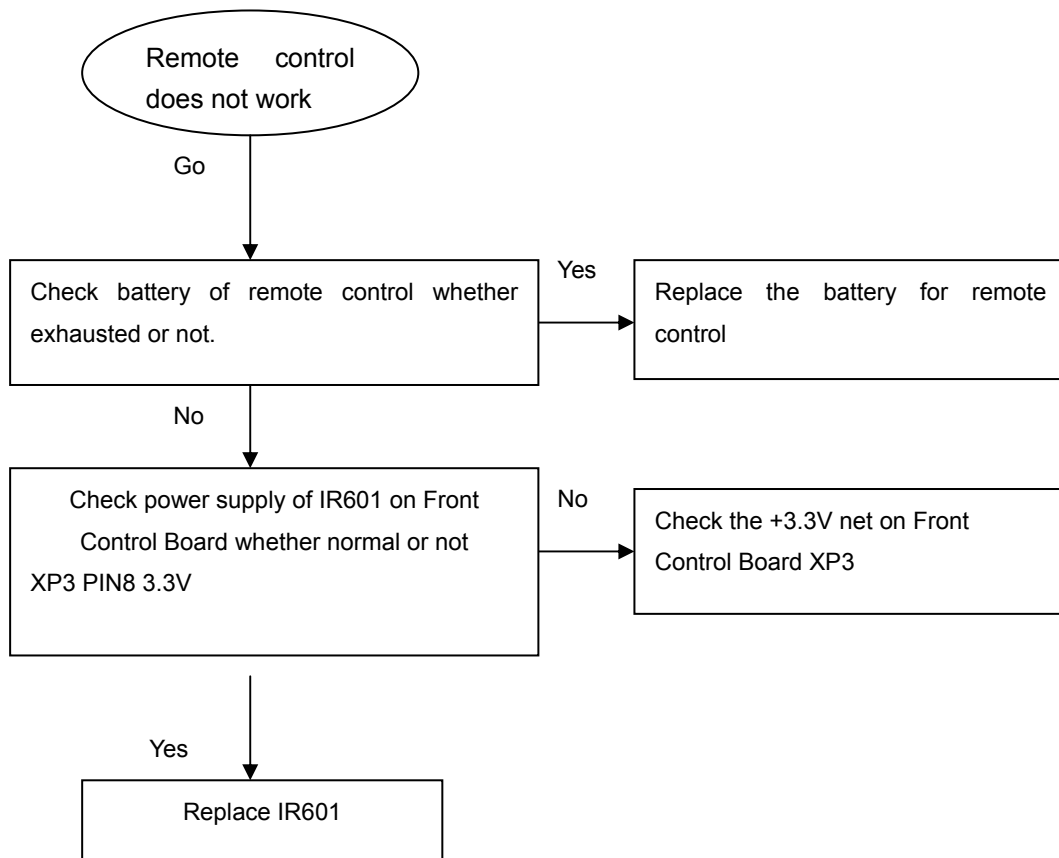

**Remote control does not work**

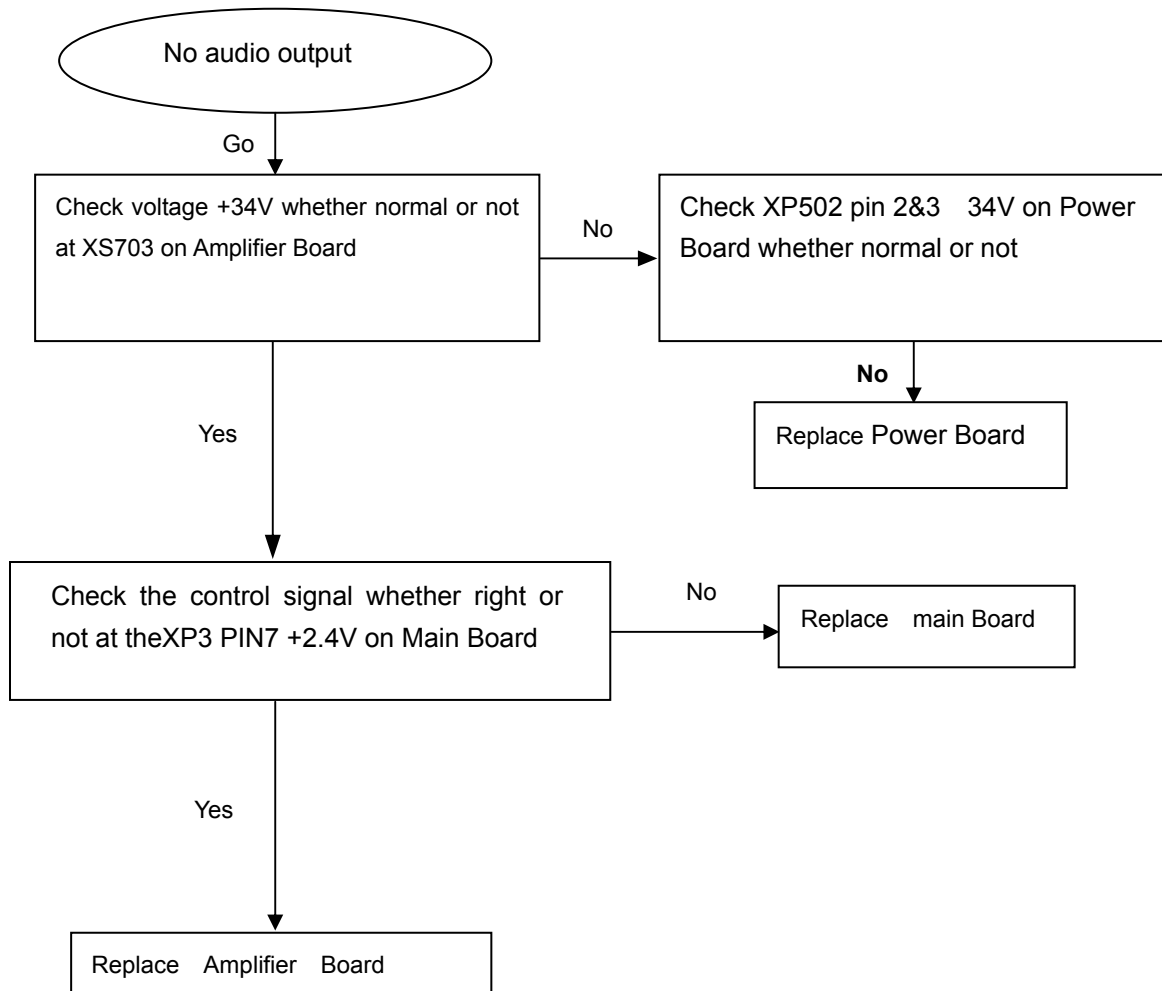
**No audio output**

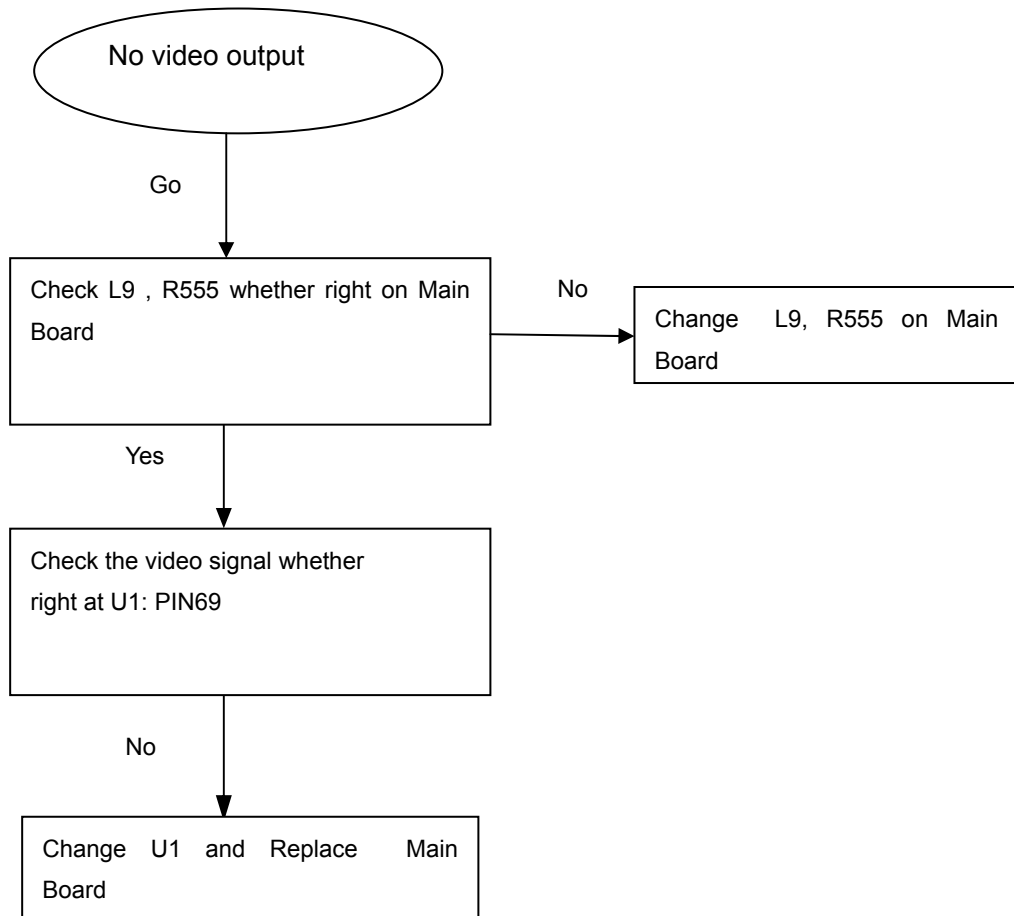
**No video output**

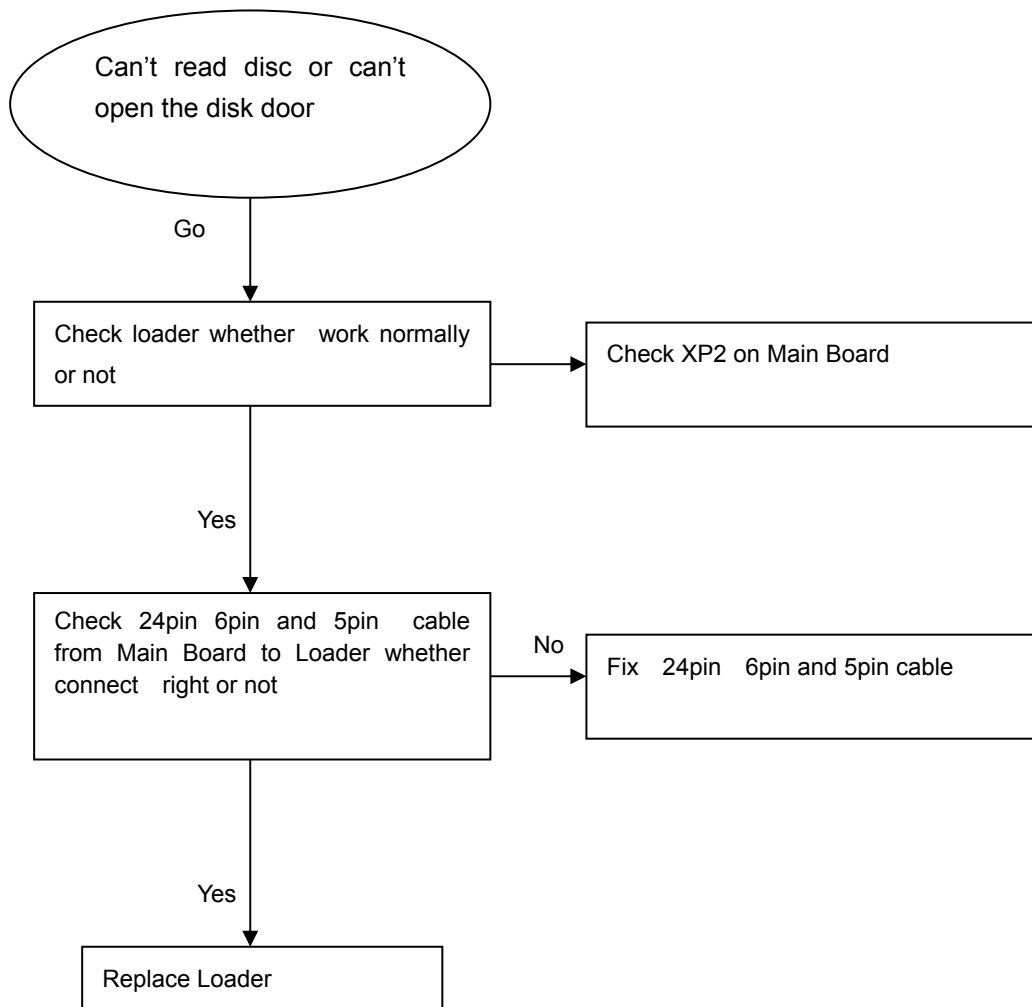
**Can't read disc or can't open the disk door**

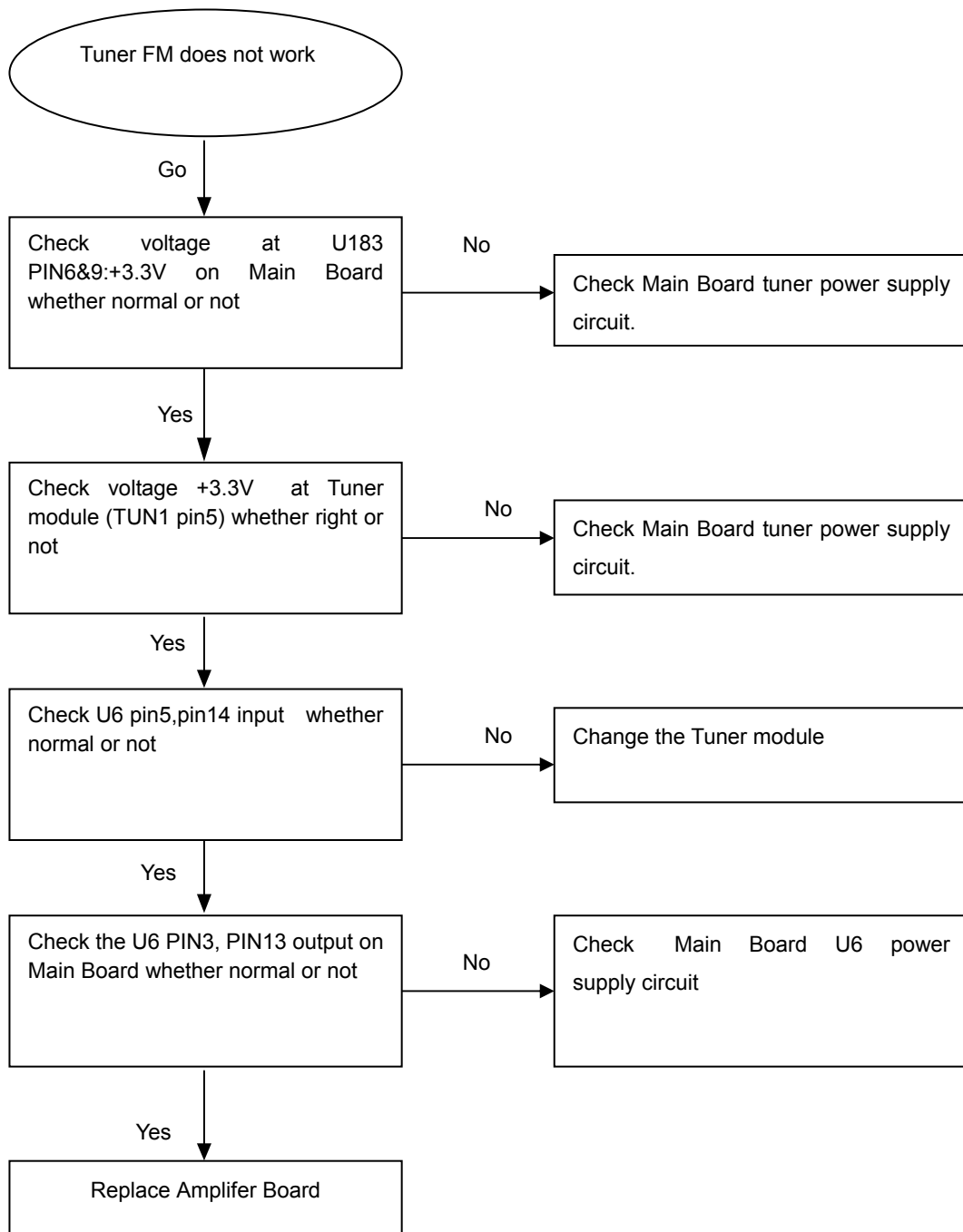
**Tuner FM does not work**

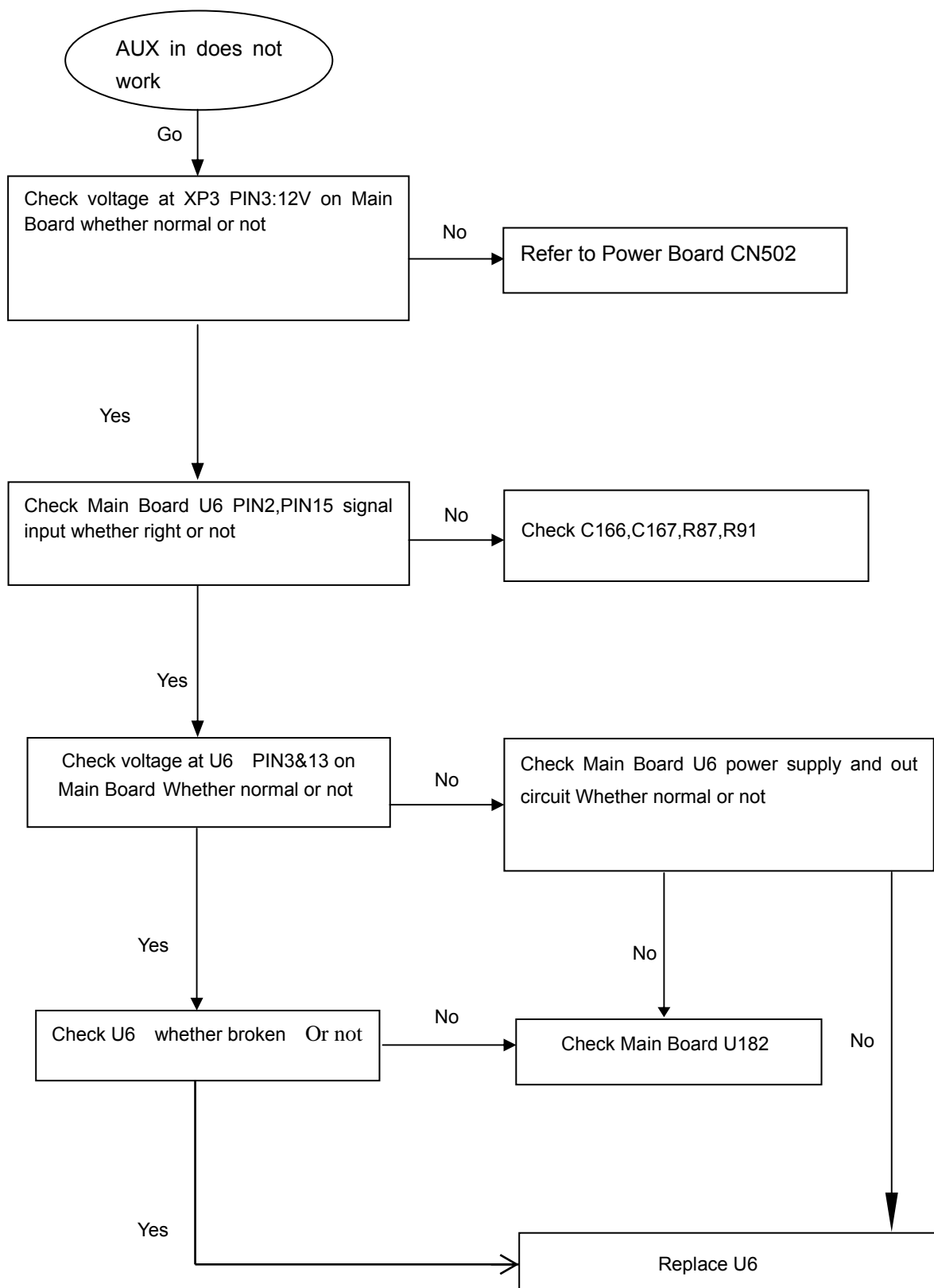
**AUX in does not work**

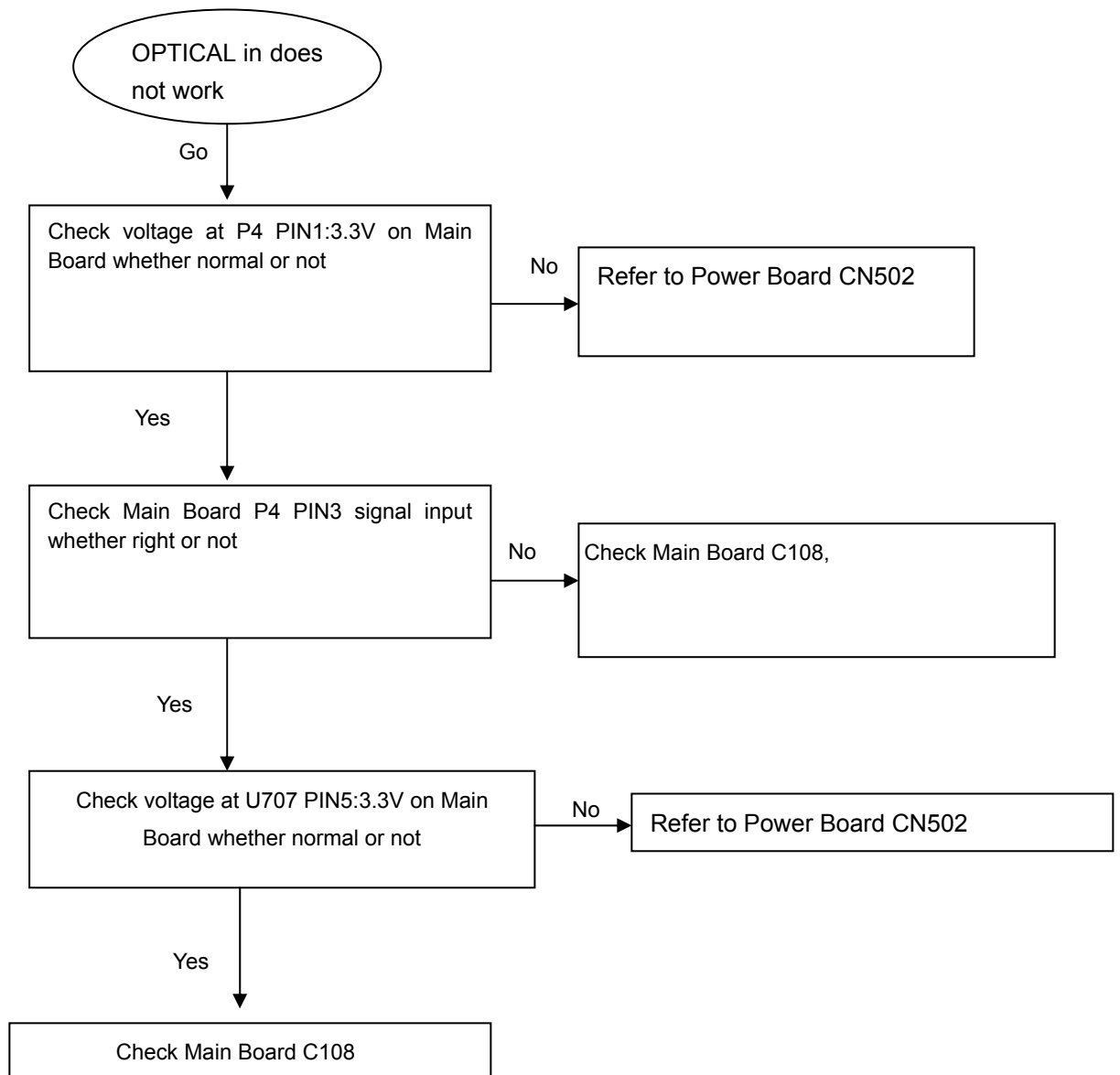
**OPTICAL IN does not work**

### HTS2512/94 Block /Wiring Diagram:

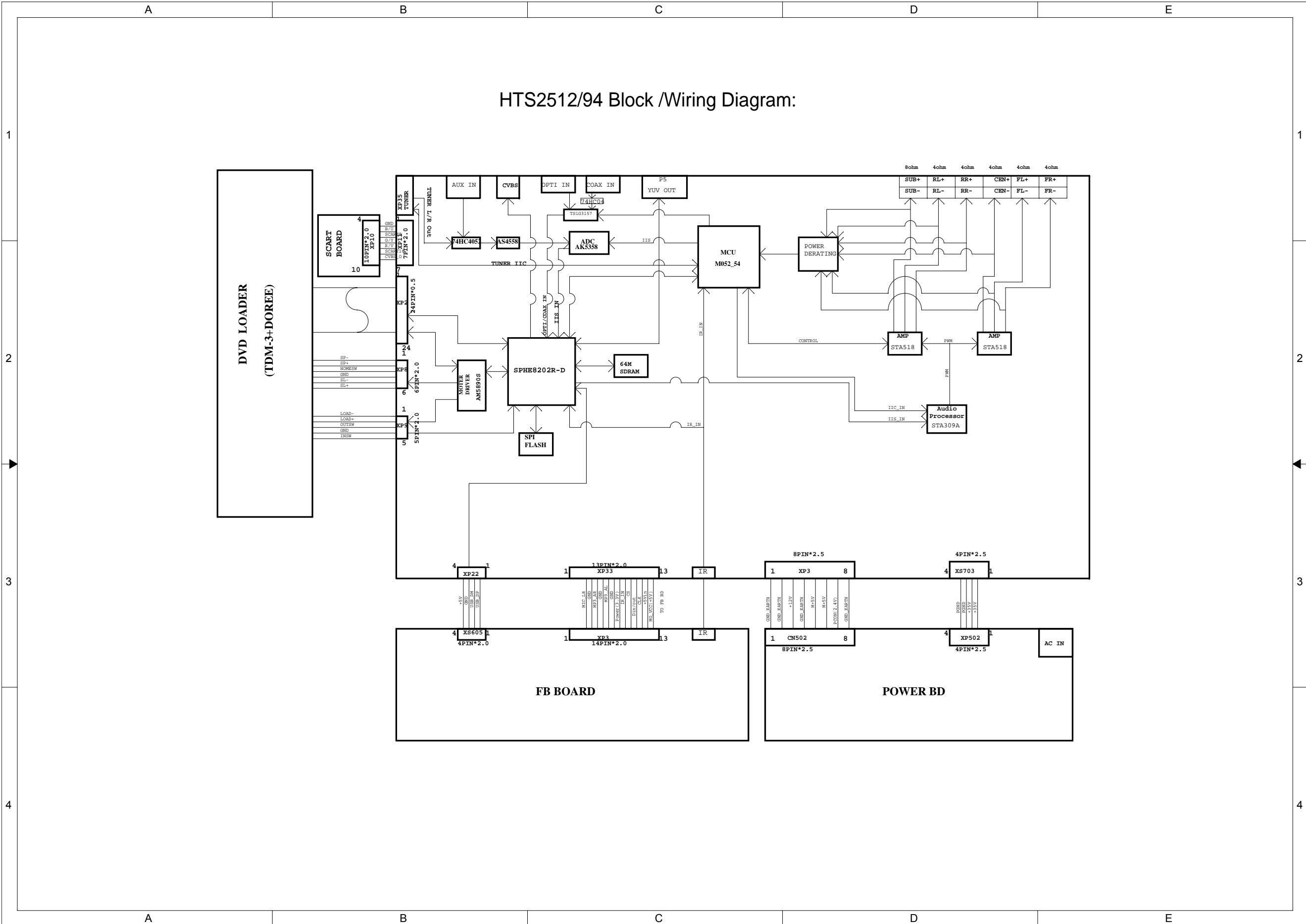
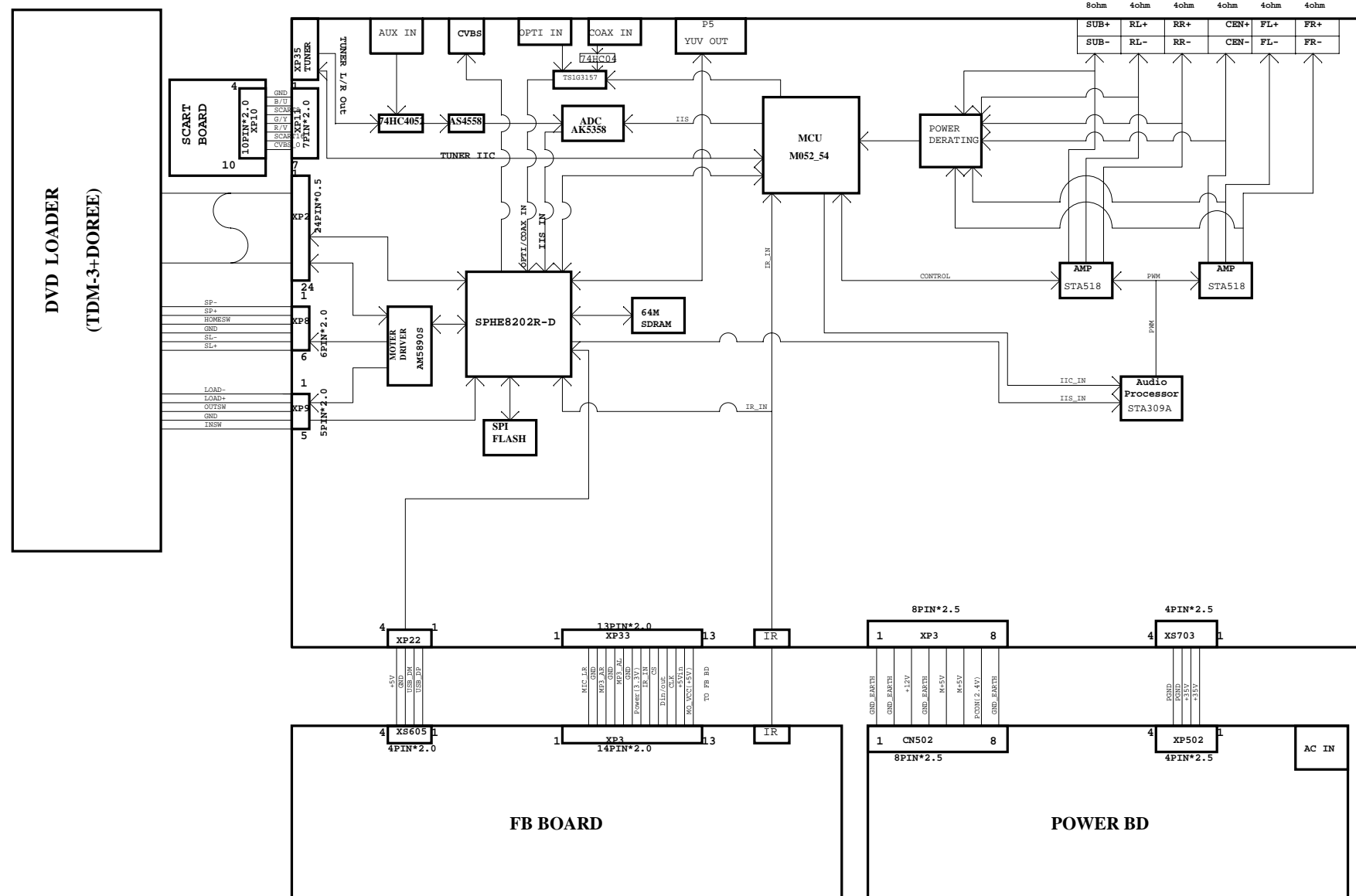



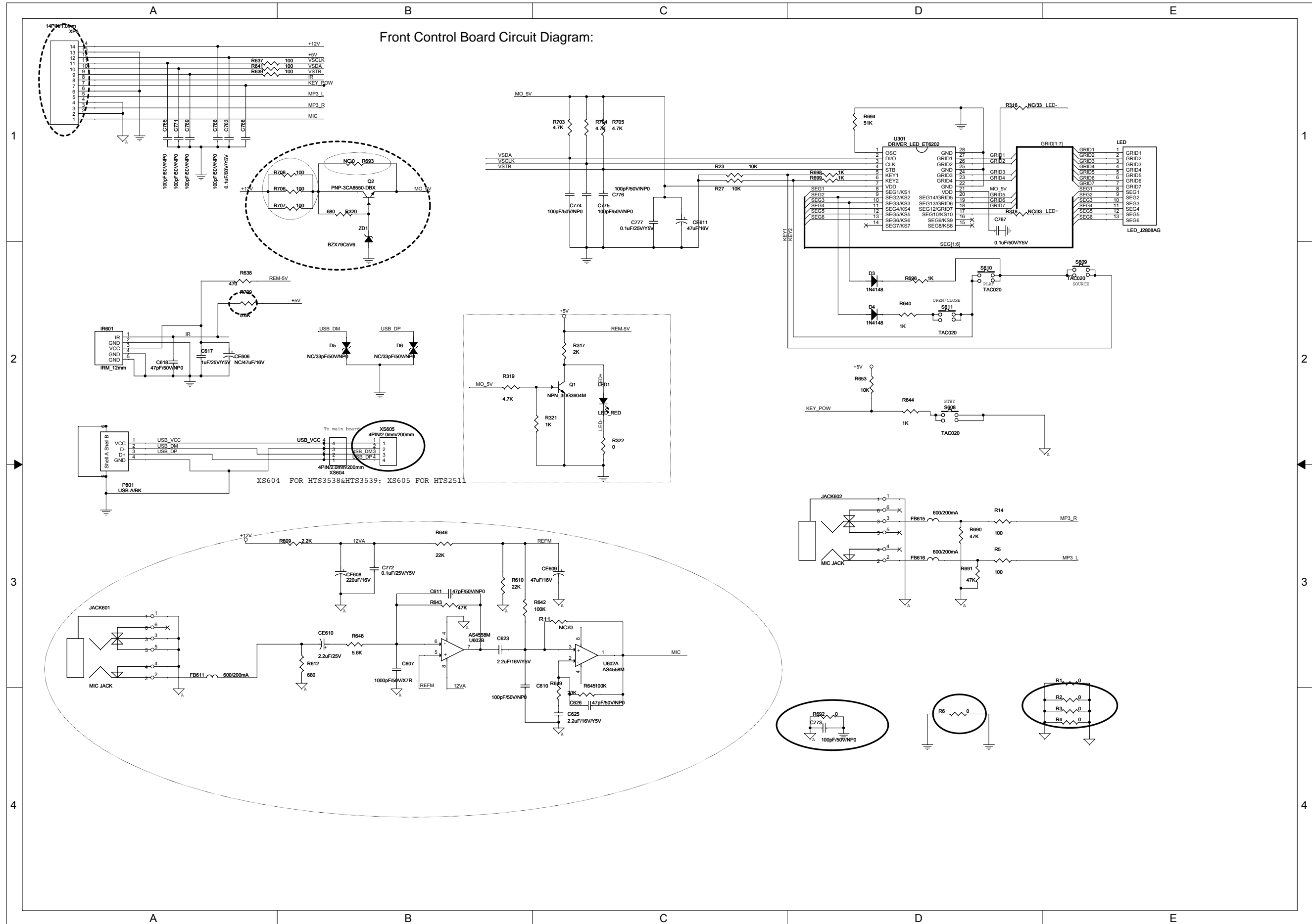

Front Control Board Circuit Diagram:

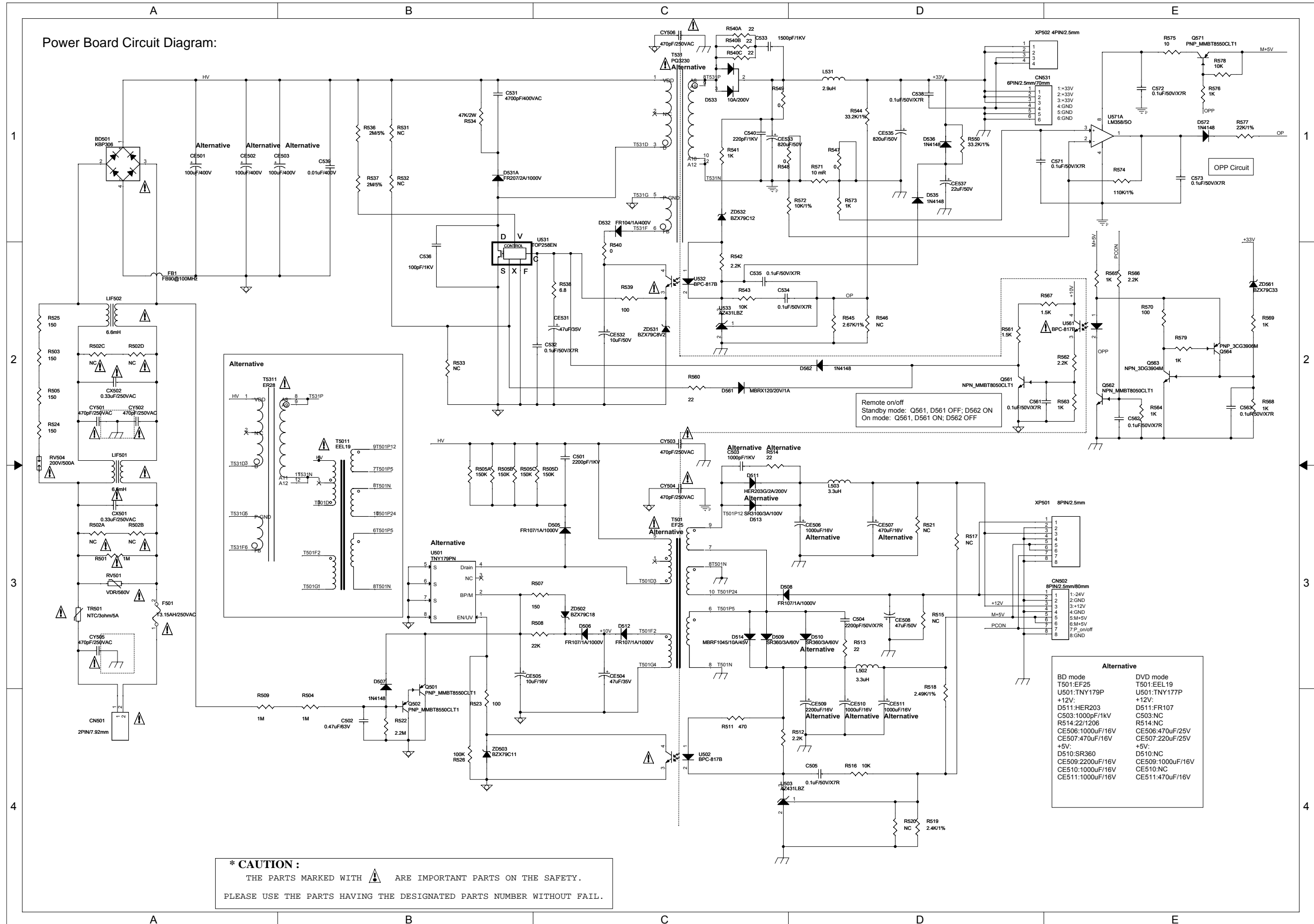

Power Board Circuit Diagram:



**\* CAUTION :**  
 THE PARTS MARKED WITH  ARE IMPORTANT PARTS ON THE SAFETY.  
 PLEASE USE THE PARTS HAVING THE DESIGNATED PARTS NUMBER WITHOUT FAIL.

**Alternative**

BD mode	DVD mode
T501:EF25	T501:EEL19
U501:TNY179P	U501:TNY177P
+12V:	+12V:
D511:HER203	D511:FR107
R514:22/1206	R514:NC
CE506:1000uF/16V	CE506:470uF/25V
CE507:470uF/16V	CE507:220uF/25V
+5V:	+5V:
D510:SR360	D510:NC
CE509:2200uF/16V	CE509:1000uF/16V
CE510:1000uF/16V	CE510:NC
CE511:1000uF/16V	CE511:470uF/16V

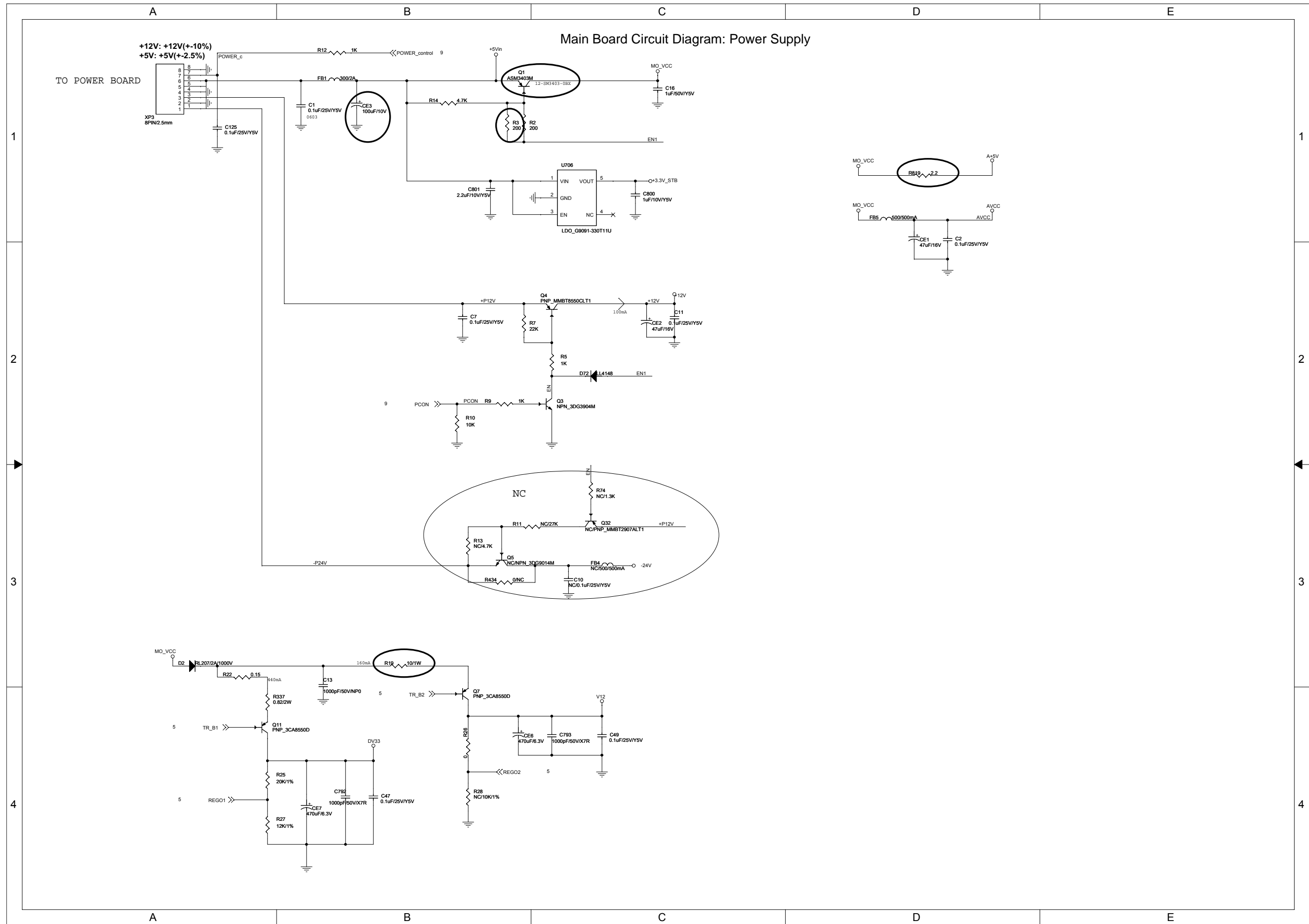

# Main Board Circuit Diagram: SPHE8202RQ-D

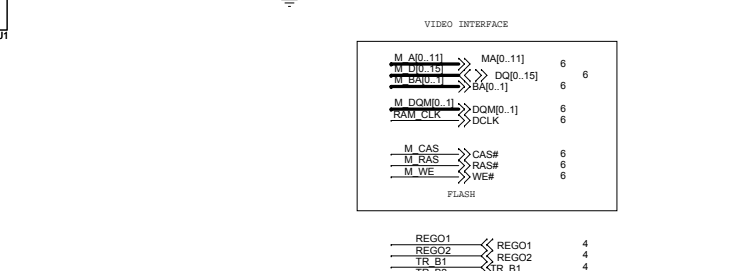
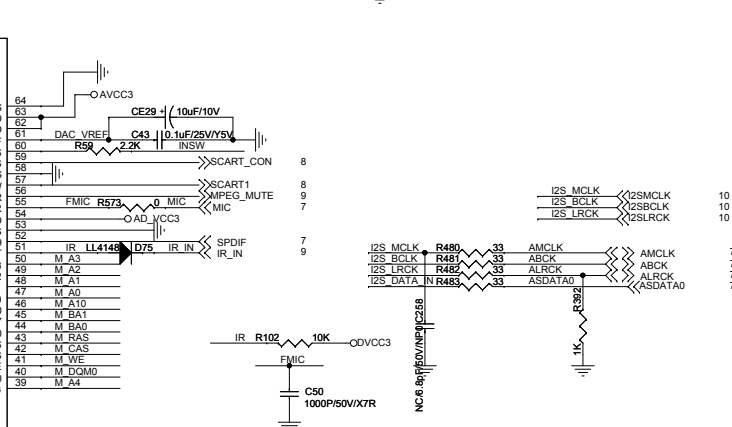
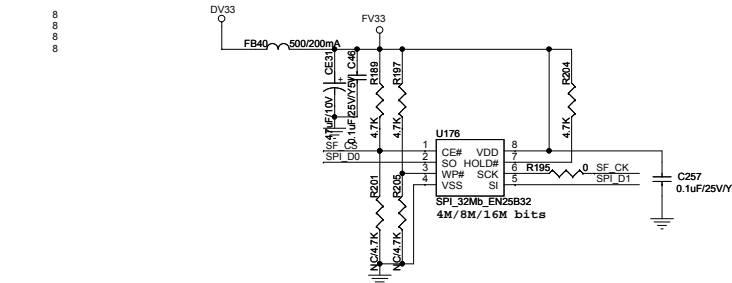
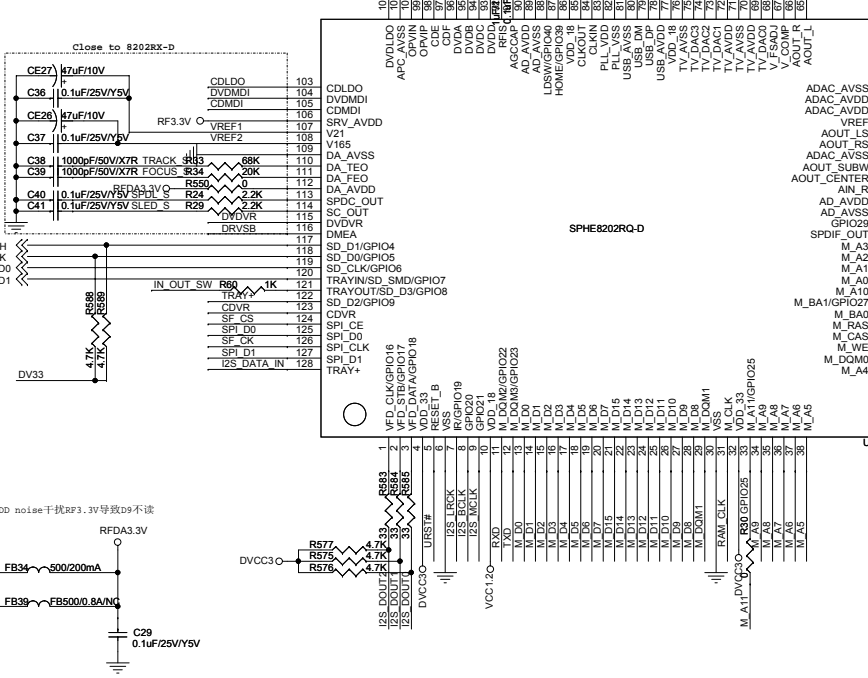
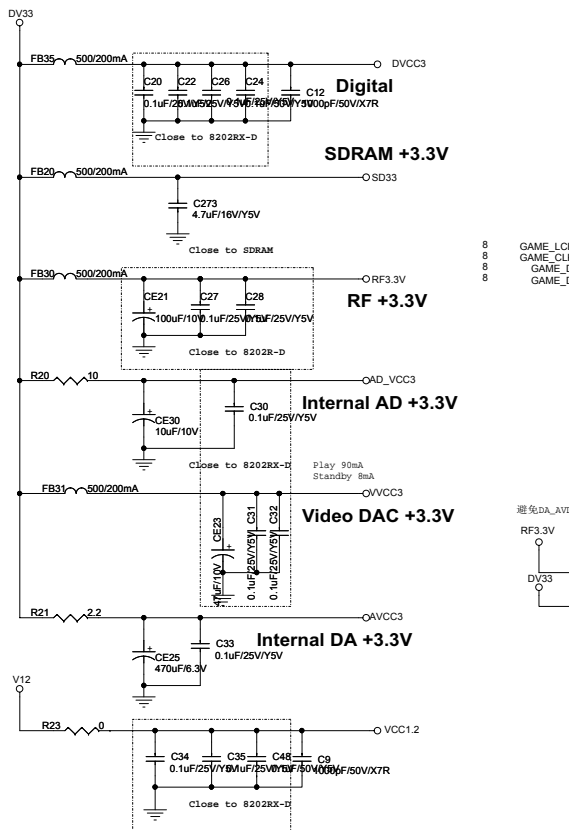
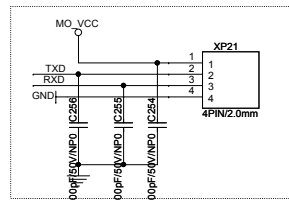
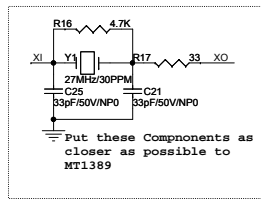

Main Board Circuit Diagram: SDRAM & USB

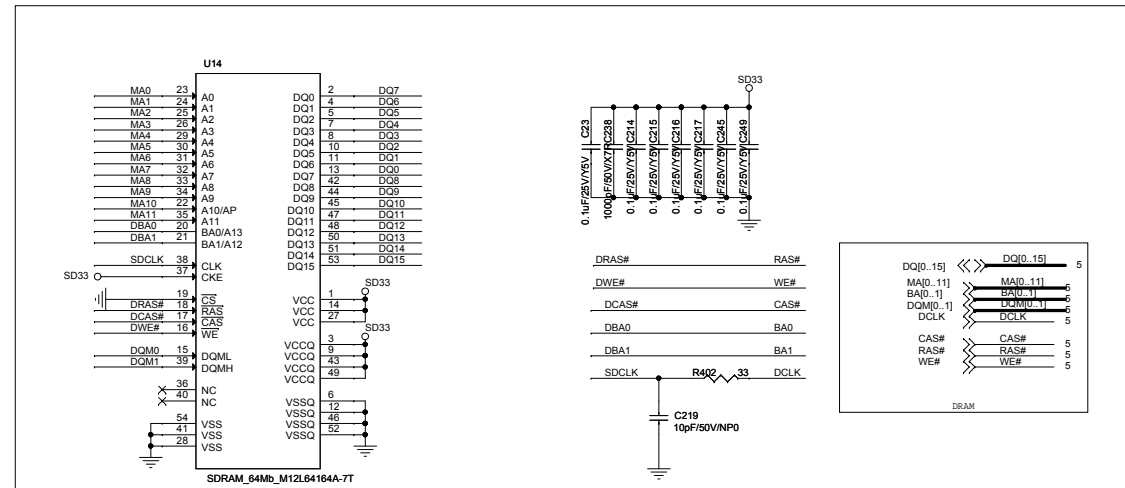

**SDRAM**

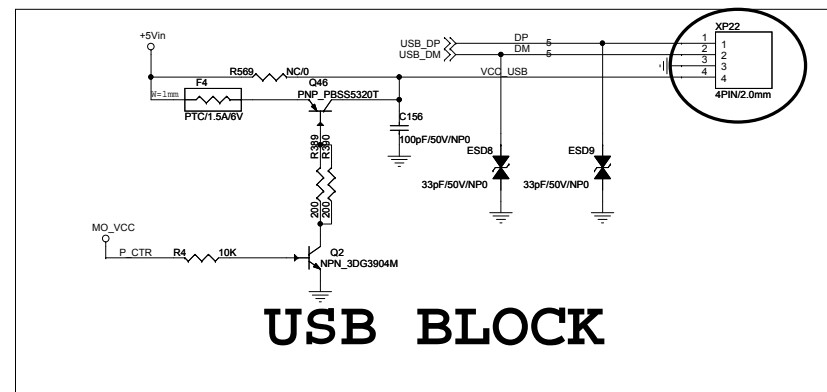

**USB BLOCK**

### Main Board Circuit Diagram: AUDIO\_IN

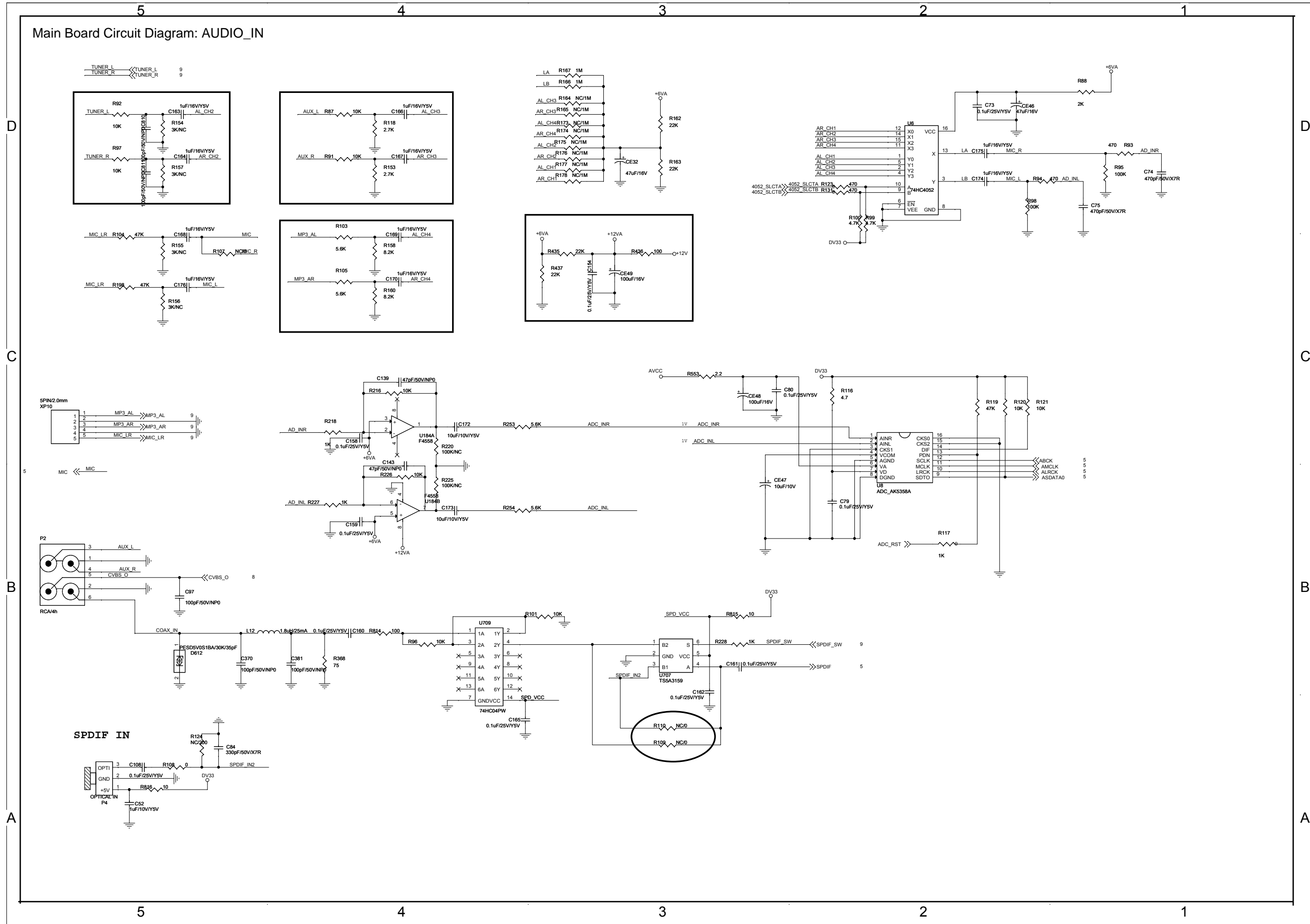

Main Board Circuit Diagram: Video Out

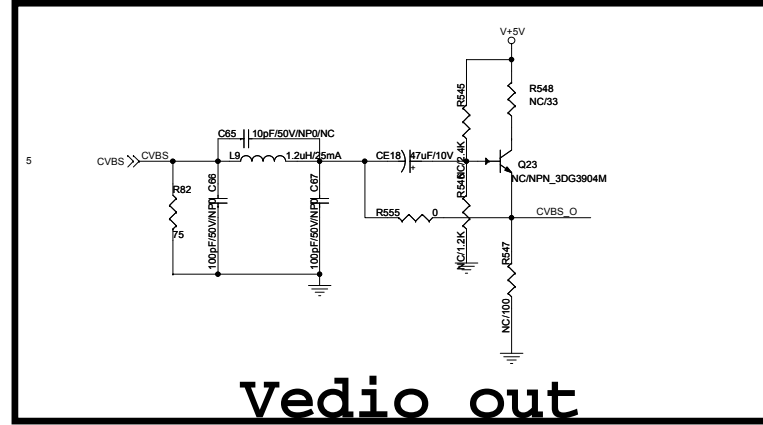

Vedio out

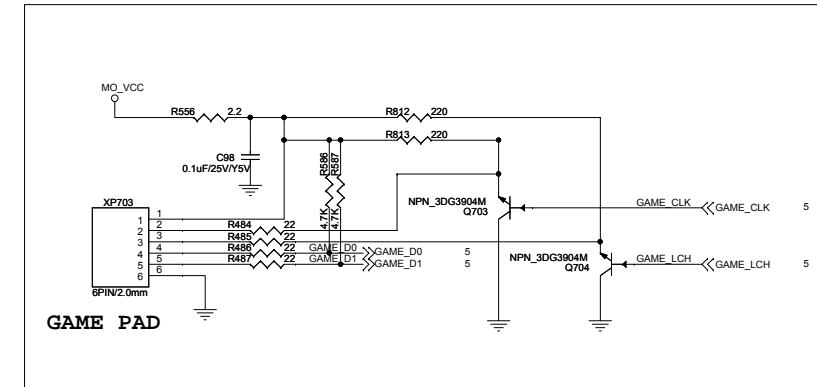
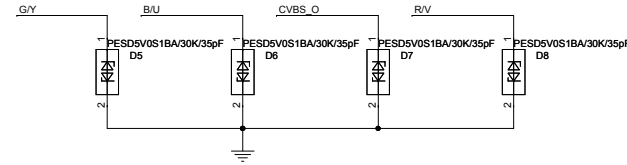
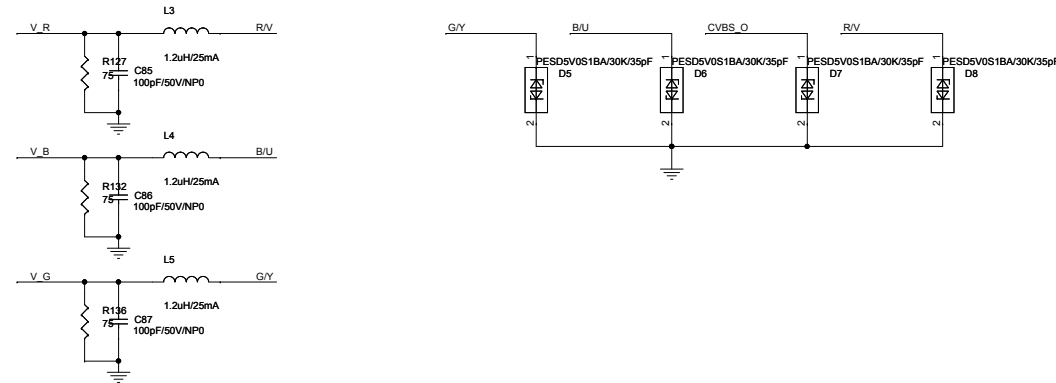
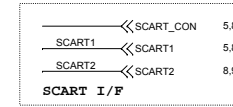
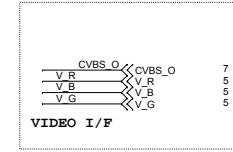
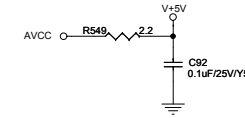
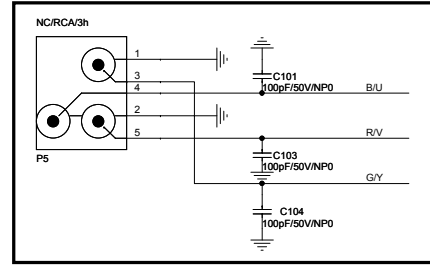

GAME PAD

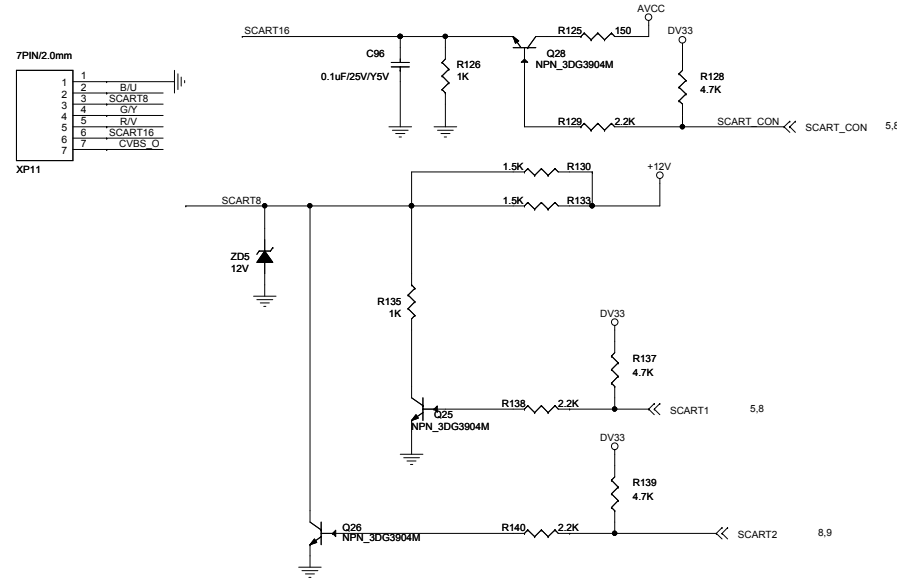

SCART_CON	SCART16
0	CVBS OUT
1	RGB OUT

SCART2	SCART1	SCART8
1	X	0 (STANDBY)
0	1	6V (16:9)
0	0	9.5-12V (4:3)

### Main Board Circuit Diagram: MCU & CONNECTOR

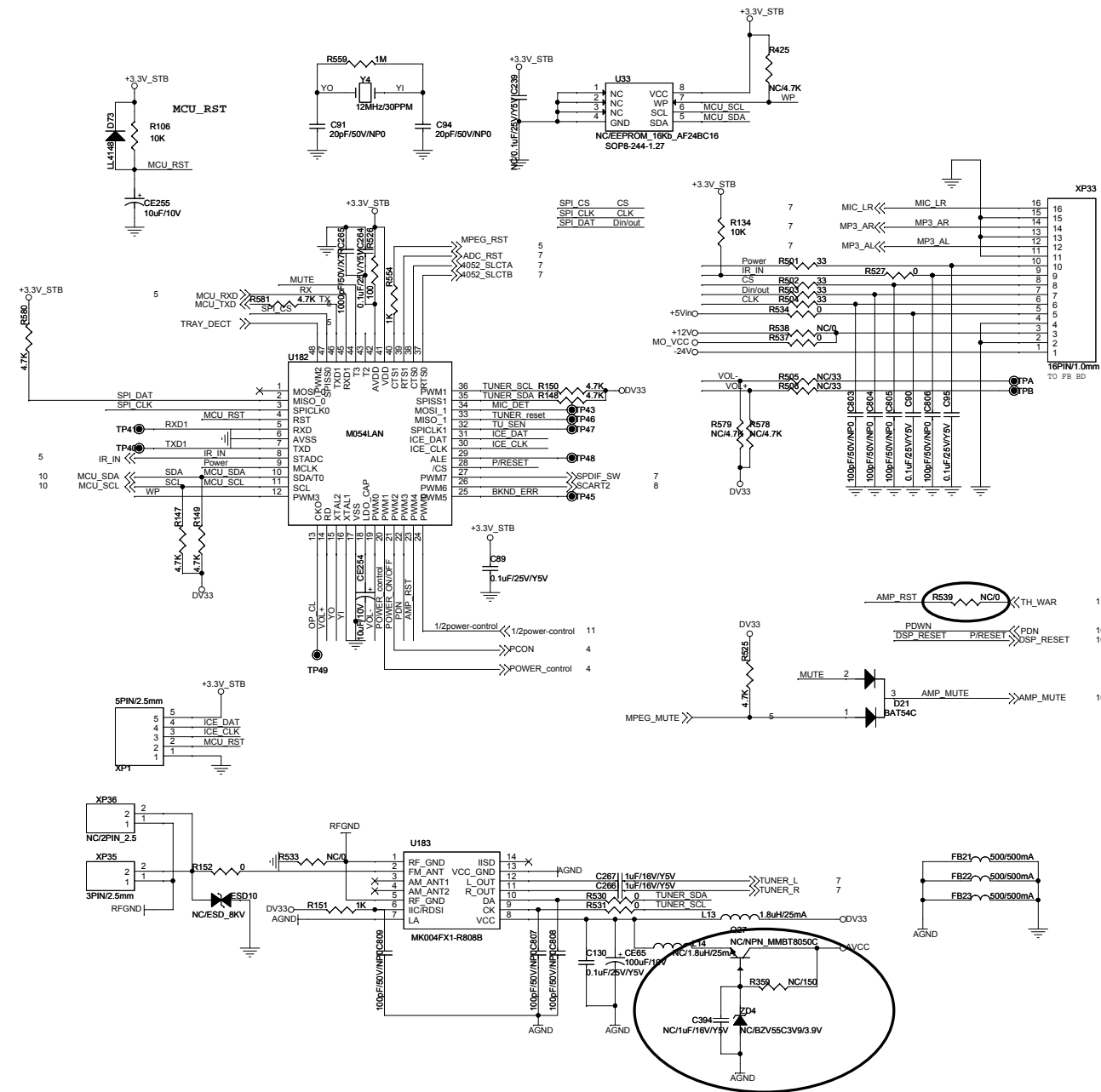





# Main Board Circuit Diagram: STA518

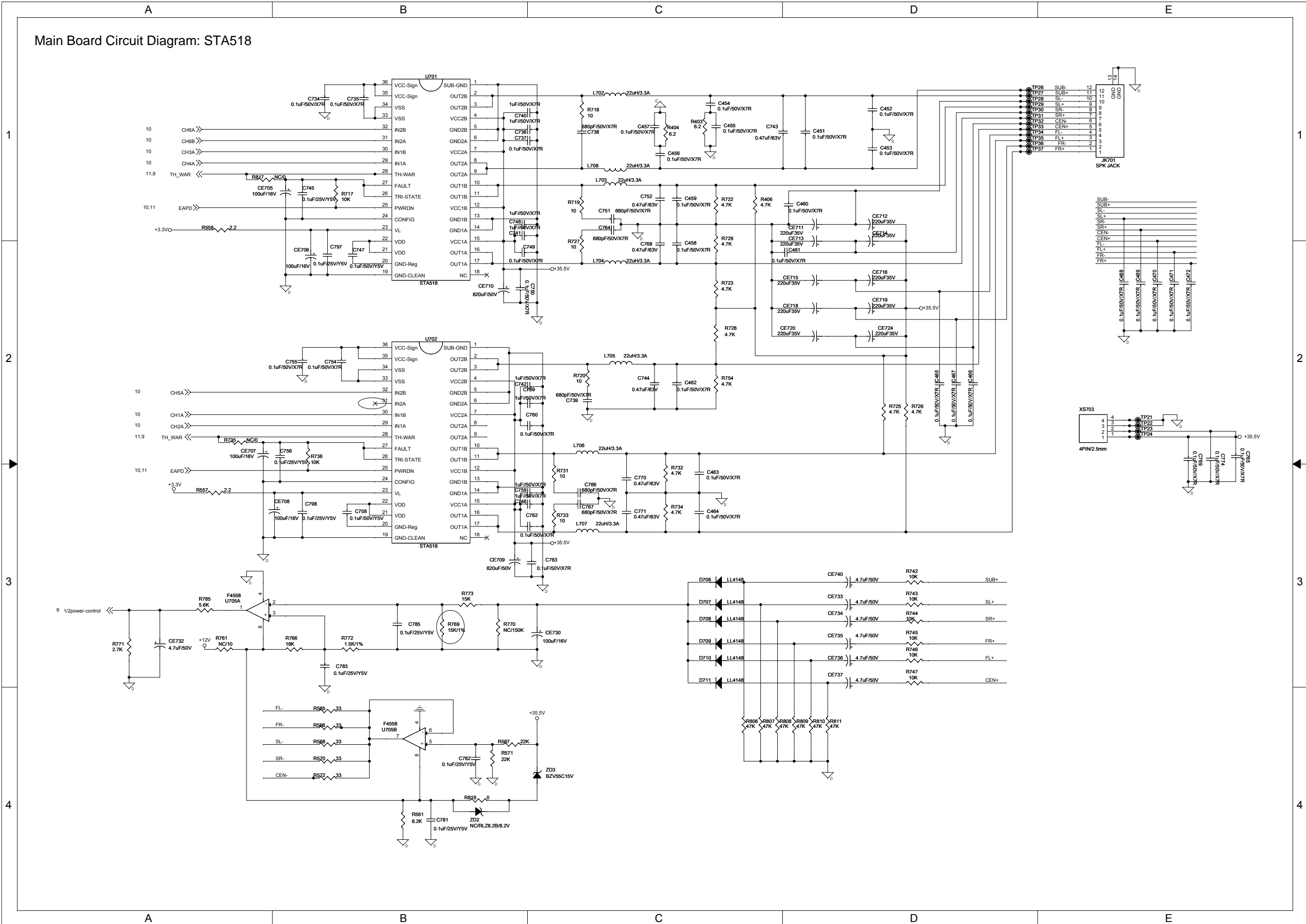

Front Control Board Print-layout (Bottom Side):

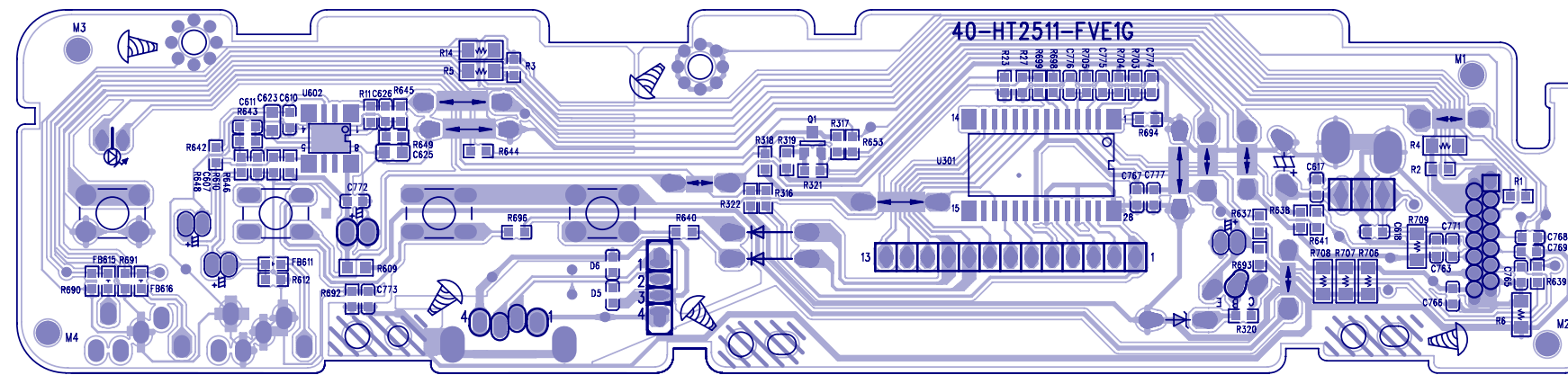

Power Supply Print-layout (Bottom Side):

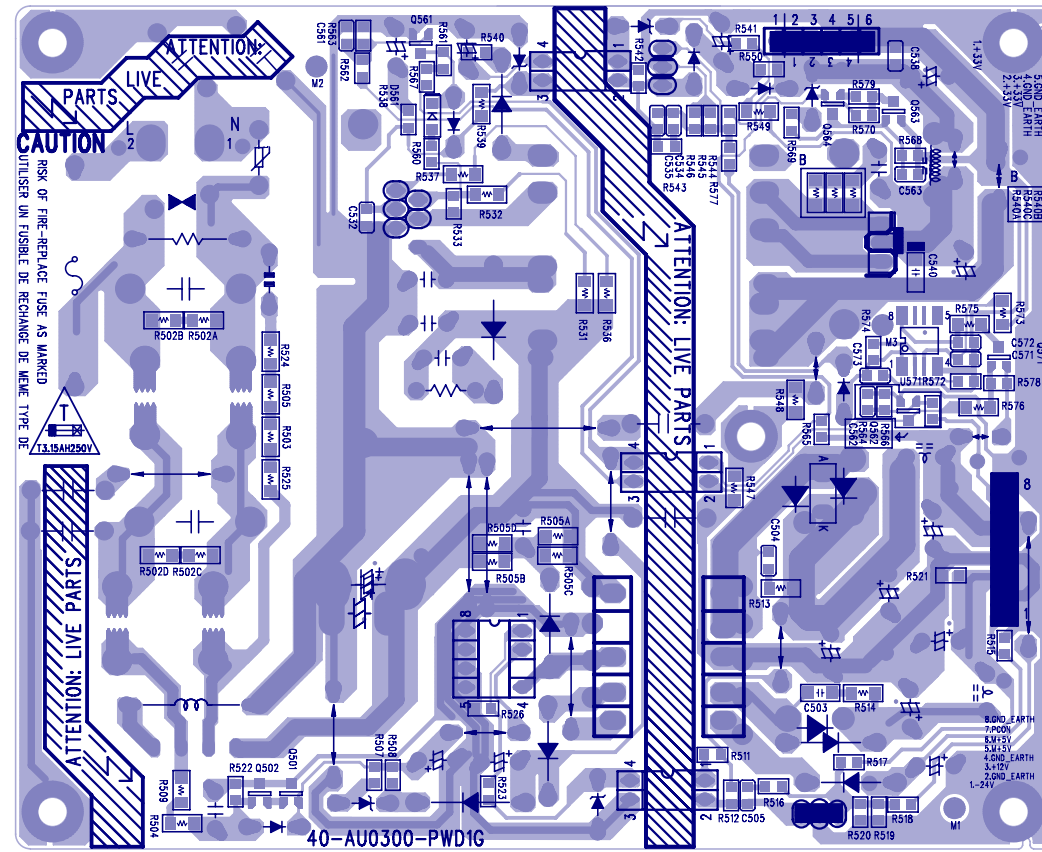





Exploded View for HTS2512/94:

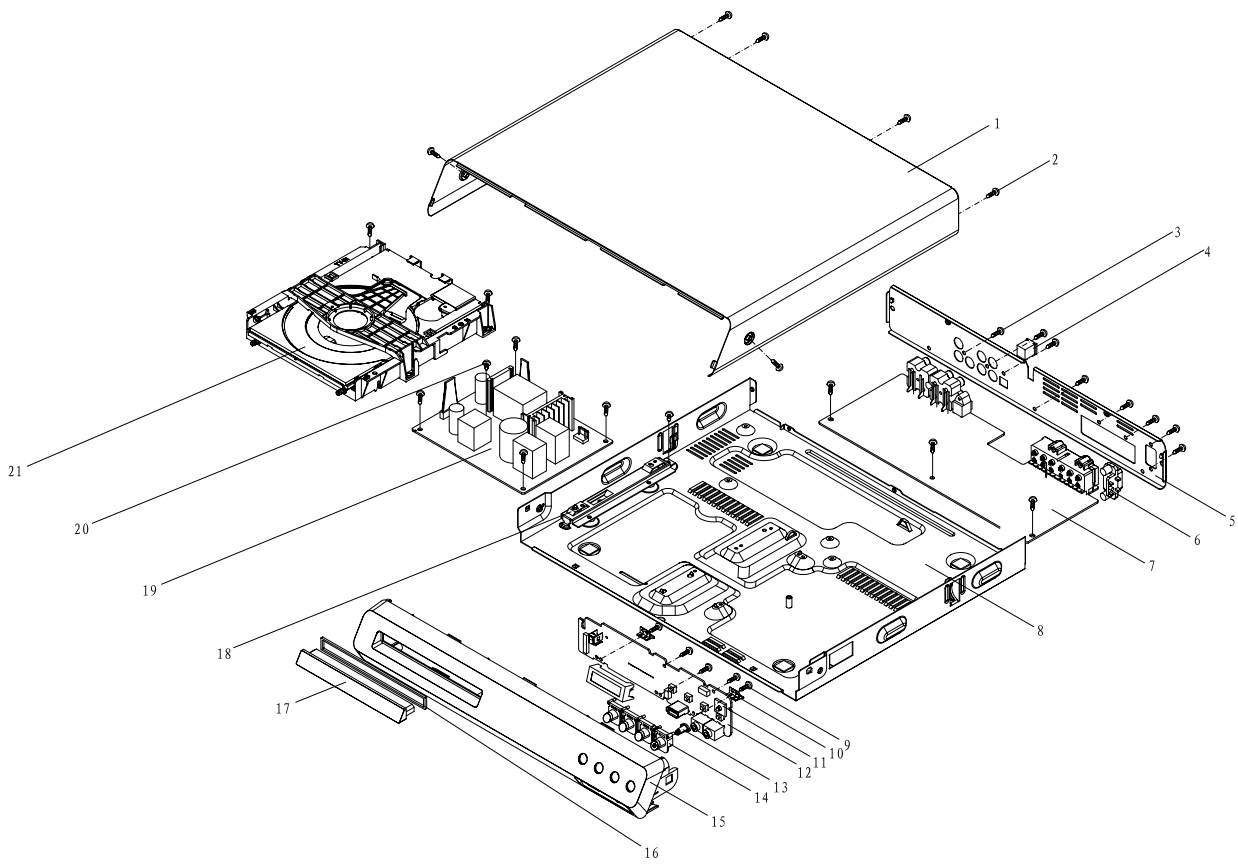

## REVISION LIST

Version 1.0

\* Initial release for HTS2512/94